

“A” Frames page 26-27

Banner Material page 24-25

Banner Stands pages 28-29

Card Easel Backs page 1

Coloured Vinyls pages 7 to 17

Coroplast page 5

Cutting Mats page 3

Cutting Tools pages 22-23

Wrap Vinyl pages 44-45



page 1



Squeegees p.20-21

Digital Imaging Vinyl pages 31 to 41

Window Glass Etch Film page 15

Grommet Machines page 4

Reflective Vinyl page 17

Safety Rulers page 3



Tapes page 47

Squeegee Applicators pages 20-21

Tape - Foam-Masking-Dble.Coated 47

Transfer Tape Premask page 1A

Velcro Brand Tape page 2



“A Frames”

SIGN & DISPLAY SUPPLY CATALOGUE



DIGITAL IMAGING FILMS pages 31-41



Vinyl Films p. 7-17

Ask for our free color swatch book for all films pages 7 to 17.



“Coroplast” “PVC” Fome pages 5-6



Banner Material page 25-26



vehicle wrap films p.44-46



1 Shot Lettering Enamel p.56-57



page 3 Cutting Mats Safety Rulers

Graphic Commerce Ltd.

1675 Sismet Road - Units 4-5

Mississauga, On L4W 2K8

(905) 624-3124 toll free 1-800-543-2796

email - info@graphiccommerce.com

website- www.graphiccommerce.com

Order by phone or email or Online



Grommet Supplies p.4

PRICES SUBJECT TO CHANGE

Easel Backs - Showcard Board - Paper

WHITE SELF-STICK . . . EASY DISPLAY

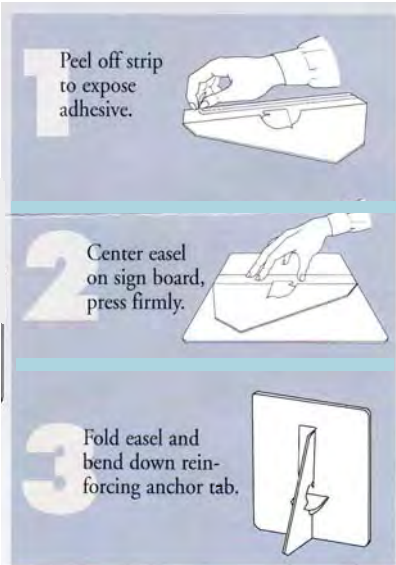

WHITE SELF STICK EASELS

Self-stick easels are attractive, sturdy and easy to use. Application is fast and easy. Simply peel and stick. No messy glue.



Single Wing



Double Wing

note: - attached sign not included

SINGLE WING WHITE SELF STICK

SIZE	1-99	100	box of 500
5" White Self-Stick	.34 ea.	.31 ea.	.27 ea.
7" White Self-Stick	.38 ea.	.32 ea.	.29 ea.
9" White Self-Stick	.53 ea.	.49 ea.	.43 ea.
12" White Self-Stick	.65 ea.	.54 ea.	.48 ea.
SIZE	1-99	100	box of 400
15" White Self-Stick	1.04 ea.	.96 ea.	.87 ea.

DOUBLE WING WHITE SELF-STICK

SIZE	1-99	100	box of 400
7" White Self-Stick	.63 ea.	.55 ea.	.50 ea.
9" White Self-Stick	.66 ea.	.61 ea.	.56 ea.
12" White Self-Stick	.96 ea.	.86 ea.	.78 ea.
15" White Self-Stick	1.90 ea.	1.74 ea.	1.57 ea.



LARGE DOUBLE WING SELF-STICK

SIZE	1-9	10	25
23"	8.30ea.	7.80ea.	7.35ea.
39"	10.45ea.	9.90ea.	9.40ea.
62"	12.55ea.	11.95ea.	11.15ea.

For larger graphics

White - Self-Stick

Sturdy Stock

Brown Kraft Paper
Jumbo 8" diameter rolls
200 yards long

36"x 200 yds.	53.75
48"x 200 yds.	67.75



A heavy DD60 general wrapping paper.
Also used for Pounce Patterns.

PETERBORO **CARDBOARDS** Showcard Board -

1900 White Showcard W28" x 44" 14 ply (.50pt.) clay coated white 1 side

PAINTS: - acrylics, latex, tempera, "1 shot Poster"

MULTIMEDIA: - vinyl graphics, felt markers, pen, ink.

8.70ea.

Quantity Discounts
on Peterboro Board

1 to 9 sheets - 8.70 sheet
10 sheets - 7.83 sheet
25 sheets - 7.40 sheet





Premask Transfer Tapes & Paint Mask

SERIES 4075 RLA- 100 yard rolls



R Tape Conform Series® application tapes and premasks with RLA® Release Liner Adhesion lay flat and stick to slick release liners to resist tunnelling, wrinkling & edge curl, even when graphics are rolled.

- All Purpose application tape for the majority of signmaking applications
- Most popular application tape available
- Small and Medium size plotter and die cut lettering and graphics

SIZE	PRICE
1 1/4"	9.85
2 1/4"	17.95
3 1/4"	26.10
4 1/4"	33.60
6 1/2"	51.05
8 1/2"	66.15
10 1/2"	80.85
12"	92.40

SIZE	PRICE
14"	106.05
16"	124.95
18"	140.70
20"	152.25
24"	185.85
30"	225.75
36"	280.35
48"	366.45



SERIES 4050 APLI-TAPE - 100 yard

SIZE	PRICE
24"	124.95
30"	156.45
48"	248.85
54"	280.35

A medium- tack paper application tape, R Tape 4050 allows easier release of larger graphics and those with high gloss levels, and is also suitable for lifting printed graphics without the risk of damaging the print. Works well in wet applications. Economically priced. Has the same features of the Conform series but without the RLA Conform release liner adhesion additive



AT-60 CLEAR

Clear Application Tape 100 yd. roll

AT-60 Clear Choice is an economical, ultra-clear application film which is priced as an alternative to standard grade application paper. AT-60 Clear Choice features a slightly tackier adhesive, which facilitates the transferring of problematic vinyl films. The new adhesive system is very forgiving. If adhesive touches adhesive, the Clear Choice film pulls apart easily, with no adhesive delamination.

SIZE	PRICE
12"	90.30
14"	110.25
24"	177.45
30"	238.35
48"	366.45



MACmark® PAINT MASK - YELLOW

Product Description Version #1 (0923) Approved by NG Paint Mask PM338400 is a 3.5-mil, Yellow, matte vinyl film coated on one side with a low peel, acrylic, pressure sensitive adhesive with a 78# clay coated release liner. The adhesive is designed for stenciling on just about all flat smooth surfaces. It can also be used on canvas and other flexible face stocks to mask large areas cost effectively and provide easy removability. Additional features include, clean, quick, trouble free cutting with most plotters. Fast, easy weeding and a textured surface to help reduce over spray problems.

Price per yard (Roll)

WIDTH	1-9 YDS	10 YDS	50 YDS
24"	4.80	4.40	201.85
30"	5.50	5.00	241.00
48"	7.65	7.00	369.00
54"	8.40	7.75	456.00

Paint Mask (Stencil Mask) - white or yellow

A specially formulated PVC facestock with removable adhesive. Used for stenciling on flat or curved surfaces. Excellent for removable vinyl letters. Available in white or yellow



WHITE PAINT MASK - PRICES

YELLOW PAINT MASK - PRICES

WIDTH	1 to 24 YDS.	25 YDS.	50 YDS. (ROLL)
24"	6.00 per yd	5.50 per yd.	5.00 yd. 250.00
48"	11.95 per yd.	10.90 per yd.	9.90 yd. 495.00

WIDTH	1 to 24 YDS.	25 YDS.	50 YDS. (ROLL)
24"	6.00 per yd.	5.50 per yd.	5.00 yd. 250.00
48"	11.95 per yd.	10.90 per yd.	9.90 yd. 495.00

MAGNETIC SHEETING

Magnetic sheeting is great for automotive, truck signs, bulletin and game boards. The sheeting cuts easily with a knife, scissors or dies.
 Advertise your company on a sign that can be permanent or easily removed from your vehicle.

24" WIDE MAGNETIC VINYL

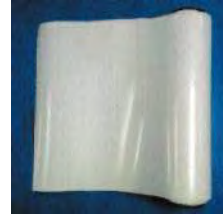

see printing specs

FOR BUSINESS:

[click here for a detailed sheet on clean and care guidelines](#)

Thickness	Type	Rolls - 24"x50 ft.	Cut Pieces
.030	Matte White	219.00	4.70 per lin. foot
.030	Gloss White	219.00	4.70 " " "
.030	P/S Adhesive	219.00	4.70 " " "
.030	Magnet only	183.00	4.25 " " "
.020	Matte White	183.00	4.25 " " "
.020	Gloss White	183.00	4.25 " " "
.020	P/S Adhesive	183.00	4.25 " " "
.020	Magnet only	136.00	3.25 " " "
.015	Matte White	165.00	3.75 " " "
.015	Gloss White	165.00	3.75 " " "
.015	P/S Adhesive	165.00	3.75 " " "

Now Available! Magnetic Rolls in extra wide 48" width

- .030 Matte White - 48"x 50 ft. long - (rolls only) - 490.00
- .020 Matte White - 48"x 50 ft. long - (rolls only) - 390.00



New!! High Energy Magnetic Sheeting .030ga.
Stronger holding power than normal 40 mil magnets.
 Gloss White - Both sides magnetic - 24" width
 Prices: Roll 24"x45ft.-259.00 Cut pieces 24"wide - 6.95 lineal ft.
[click here for more info and specs.](#)

MAGNETIC SHEETING

Magnetic Vinyl Tape .060 w/3M #9448 PSA adhesive back

- 1/2" x 100 ft. roll **29.00**
- 1" x 100 ft. roll **56.00**
- 1/2" x 100 ft. roll w/grooves - (type A) **29.00**



High Energy -Magnetic Vinyl Tape - High Energy

- .060 w/ 3M #9448 PSA adhesive back
- 3/4" x100 ft. roll - 49.50 per roll



Rhino Cutting Mat



It's Self Healing

Note: Optional grid shown above is placed underneath the white translucent mat.

Straight Cutting - Mats won't gouge
 Unique Matte Finish - Easy on the eyes
 Seamless Self-Healing Virgin Polymer
 Protects Table Top - Blades Last Longer
 Thick .180 Inch Quality - Solvent Proof
 Our mats Roll Up for Easy UPS Shipping

MAT SIZES AND PRICES - UNPRINTED

2ft.x4ft.	4ft.x6ft.	4ft.x8ft.	4ft.x10ft.	4ft.x12ft.	4ft.x16ft.	5ft.x8ft.	5ft.x10ft.	5ft.x12ft.	6ft.x10ft.	6ft.x12ft.
85.00	234.00	393.00	457.00	621.00	393.00	475.00	437.00	566.00	566.00	694.00
Optional Grids - 4x2ft.-42.00		4x8ft.-61.00		4x12ft.-93.00		6x12ft.-170.00		Custom size grids available		

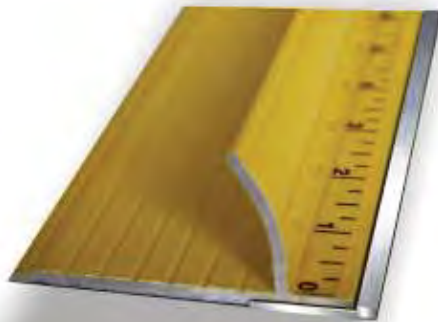

Steel Plate Married To Aluminum Straight Edge

Ultimate Steel Safety Ruler

Premium safety ruler features a steel plate insertion to the straight edge, along with a taller curved hand guard, extra wide base, steel cutting surface, and tough yellow powder coating.



28"	- 164.00
40"	- 219.00
52"	- 295.00
64"	- 345.00
76"	- 419.00
100"	- 529.00

RACKS FOR STORING VINYL ROLLS



Chrome plated wall mount
 164.00

Heavy Duty - Holds 16 rolls of up to 30" width material.
 Saves floor space and allows proper storage for vinyl adhesion life.
 Supplied with adjustable screw mounting clips allowing for stud alignment in most walls.



595.00

Portable Chrome Plated Floor Rack with Handle

Heavy duty construction holds 16 rolls of 2" or 3" core material up to 1000 lbs.
 - Comes with 16 high impact plastic rings to prevent storage damage to rolls.
 - Has 9 ball caster rollers to allow easy movement while fully loaded.
 - Durable enough to hold 72" wide material. Proper storage of wide material dictates supporting rolls by the core to prevent damage to roll face coating.

ROLLER FOR VINYL



217.00

20" Roller Tray-Accommodates any size roll.

-Handles any width material up to 350 lbs.
 -to un-roll or re-roll material with ease without damage to the material.

GROMMETS, MACHINES

HIKER SELF PIERCING GROMMET MACHINE



**Model #
H-901B**

see manual here

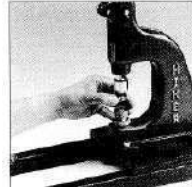

LOAD - Top Die holds grommet firmly.

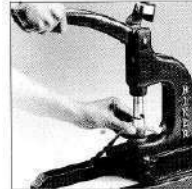

Pierce & Set - Each Grommet cuts its own hole and washer controls roll over for smooth secure fit

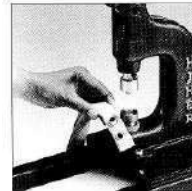

DONE - Quality • Speed • Efficiency

FASNAP PM5 SELF PIERCING GROMMET MACHINE



Fasnap Machine with #0 #1 or #2 die	-520.00
Fasnap Machine with #3 or #4 die	-530.00
Dies only #0 #1 #2 each	-210.00
Dies only #3 or #4 each	-215.00

SELF PIERCING GROMMETS for FASNAP machine only				
No.	Size		500	1000
0	1/4"	Brass or Nickel	67.00	130.00
1	5/16"	Brass or Nickel	67.00	130.00
2	3/8"	Brass or Nickel	137.00	264.00
3	7/16"	Brass or Nickel	152.00	274.00
4	5/8"	Brass or Nickel	163.00	294.00

PRICES	
Hiker machine w/either #0,#1,#2,or #1082 die	- 534.75
Hiker machine w/either #3 or #4 die	- 546.25
Dies only - #0,#1, or #2/#1082 die	- 149.50 ea.
Dies only - #3, or #4 die	- 161.00 ea.

Note: #2 Hiker die fits both standard and long barrel #2 Hiker grommets



#2
brass

SELF PIERCING GROMMETS

FOR HIKER MACHINE GROMMETS

PRICES	CAT. NO.	INSIDE HOLE	BRASS		NICKEL OR BLACK	
			500	1000	500	1000
			# 0 Grommet	SPU	1/4"	\$57.50
# 1 Grommet	SPV	5/16"	\$77.00	\$134.55	\$89.20	\$157.55
# 2 Grommet	SPW	3/8"	\$89.70	\$152.85	\$100.05	\$172.50
# 3 Grommet	SPX	7/16"	\$130.95	\$202.40	\$129.95	\$231.15
# 4 Grommet	SPY	1/2"	\$158.70	\$274.85	\$181.70	\$318.55
#2 Long Barrel Grommets 10MM or 6MM			\$166.75	\$289.80	\$195.50	\$332.35

LONG BARREL GROMMETS

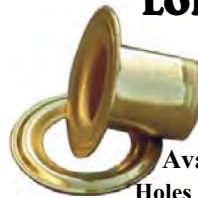

10mm (1/2" or 6mm (1/4"))
for use with 10mm or 6mm stock
eg. foam board, Coroplast, etc.

Available in #2 size only (3/8" inside dia.)

Holes must be drilled due to length of grommet.

Note: Hiker #2 die fits both standard & long barrel grommet.

6MM OR 10MM	1 to 499	500	1000
BRASS	.44 ea.	166.75	289.80
NICKEL	.46 ea.	195.50	332.35

OSBORNE MANUAL GROMMETTING TOOLS

GROMMET DIE SET #216 OSBORNE



No.	Grommet inside hole dia.	Price
216-1	5/16" for #1 grommet	56.95
216-4	1/2" for #4 grommet	73.00

MANUAL GROMMETS AND WASHERS



Osborne Grommet & Washers
For Osborne #216 Die Sets & Mini Kits

No.	Size	Per Box of 144	Brass
#3	7/16"	i.d. hole dia.	38.75

GROMMET HOLE CUTTER #500



No.	For Grommet size	Price
1A	1-5/16"	27.25
4A	1/2"	31.85

MINI GROMMET KIT

FOR SMALL JOBS
(Canvas, plastic, nylon mesh)

- EACH KIT CONTAINS:
- Grommet Die (Mini)
 - Punch (Mini)
 - Cutting Board
 - Instructions on back pkg.
- GROMMETS:
- Kit #0 or #1 contains 4 dozen



PRICES		Brass	Nickel
#1 KIT	5/16" dia.	26.50	
#3 KIT	7/16" dia.	31.50	
#4 KIT	1/2" dia.	32.50	34.00

NOTE 4x8 ft. sheets available for delivery only in Toronto GTA & nearby areas eg. Hamilton, Niagara, Cambridge, Kitchener, Oshawa, Whitby, etc. - Phone or email order.

ACM PANELS- ALUMINUM COPOSITE MATERIAL- white, black, brush silver, colors
INEXPENSIVE - LIGHTWEIGHT - HIGH STRENGTH

ALUMINUM SIGN PANEL

3mm - 48"x 96" (4x8 ft.)

1 side Gloss white/ 1 side Matte white	#724851- 85.00
both sides Matte white	#713431 - 89.00
1 side white/1side black	#735970 - 92.00

3mm - 48"x 96" (4x8 ft.)

Brushed Gold/Brushed Bronze	#791138 - 219.00
Brushed Silver/Brushed Silver	#791139 - 219.00
Brushed Silver/Silver	#735974 - 149.00
Silver/Silver	#791142 - 175.00
Silver Mirror/Silver Mirror	#791143 - 279.00
Ultramarine Blue/Dark Green	#791144 - 177.00
Red Traffic/Yellow	#791145 - 177.00
Black/Black	#791133 - 145.00
White/White	#791127 - 125.00

6mm - 48"x 96" (4x8 ft.)

Gloss White/Matte White	#791126 - 133.00
Black/Black	#791125 - 147.00



brush silver

COROPLAST®

Coroplast is an extruded, twin-wall plastic sheet based on a high-impact polypropylene copolymer. This high quality, polypropylene profile sheet is formulated specifically for screen printing, displays and packaging. It uses a copolymer resin to increase impact and low temperature performance while retaining flexibility.

At regular temperatures most oils, solvents, and water have no effect on Coroplast, allowing it to perform under adverse weather conditions or when exposed to harsh chemicals.

Standard colours: White, Natural, Ivory, Yellow, Brown, Red, Orange, Light Blue, Dark Blue, Navy Blue, Silver Grey, Green and Black.

4' X 8' sheets	1-9 sheets	10-24	25
White - 4mm (3/16 in.)	15.95 ea.	14.95 ea.	13.95 ea.
Black - 4mm (3/16 in.)	17.95	16.95 ea.	15.95 ea.
Colours - 4mm (3/16 in.)	22.95	21.45 ea.	inquire
White - 6mm (1/4 in.)	42.00	inquire	"
White - 10mm (7/16 in.)	53.85	50.00 ea.	"
Black - 10mm (7/16 in.)	57.00	inquire	"
White - 4mm - Ultra Smooth	25.35	inquire	"

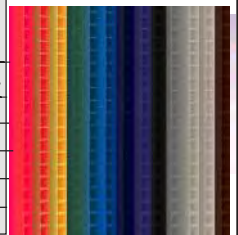

BLANKS-4MM COROPLAST

Size - White only - Price

24" x 18"	3.75 ea.
24" x 32"	check
24" x 36"	4.95 ea.

note flute directions

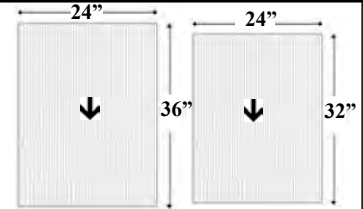

CHECK FOR PRICING ON OTHER SIZES

PLASTICS FOR DISPLAY AND PRINTING

SINTRA

FLAME RETARDANT BOARD is a rigid and strong light-weight foamed P.V.C. board which meets fire code regulations. Sold in 4' x 8' sheets. Colours: Red, Blue, Green, Yellow, Light Grey, Grey, Beige, Black. Sintra material is closed-cell, expanded plastic, high-density polyvinylchloride sheet.

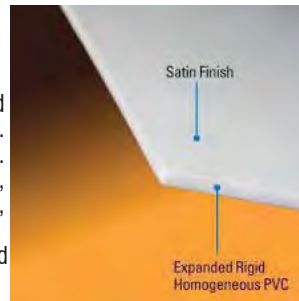

SINTRA PVC BOARD

THICKNESS	WHITE	BLACK	COLOURS
3 mm (1/8")	53.95	62.10	check
6 mm (1/4")	99.25	112.00	check
13 mm (1/2")	check	check	check
19 mm (3/4")	check	check	check
25 mm (1")	check	check	check

CREZON®BOARD

4 ft. x 8 ft.
 1/2 inch thick
 Primed 1 side only
 2 year exterior
 \$230.00 sheet

GATORFOAM®

Both Natural and White Gatorfoam panels are amazingly strong and light-weight. You can use them on a multitude of creative projects, ranging from complex theatre sets to simple photo mounts. And, because they are resistant to sun, wind and rain, both can be used indoors and out. Sold in 4' x 8' sheets.



THICKNESS	WHITE	NATURAL	BLACK
5 mm (3/16")	123.00	check	check
13mm (1/2")	check	check	check
19mm (3/4")	check	check	check
25mm (1")	check	check	check

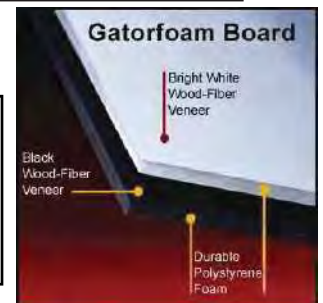

FOME-CORE BOARD

The well known light weight display material. Excellent for signs and displays. Lightweight & rigid. Sizes 48"x96" and 32" x 40" sheets sold singularly or (25 per carton)

48" x 96"

3/16" and 1/2" thick



SIZE	COLOR	Part Case	Full Case Price
48"x96"- 3/16"	White	25.00ea.	Case (25) 23.00
48"x96"- 3/16"	Black	39.35	Check for price
48"x96"- 1/2"	White	73.50	Check for price
48"x96"- 1/2"	Black	Check	Check for price

NOTE 4x8 ft. sheets on this page available for delivery only in Toronto GTA & nearby areas including Hamilton, Niagara, Cambridge, Kitchener, Oshawa, Whitby, etc. - Please Phone or email order for these sizes.

Ultra Board Classic

Ultra Board is the ultimate foam board, even stronger than gator board.
 Ultra Board is like Foam Board but with a plastic surface instead of a paper surface.
 Ultra Board is like Gator Board but with a plastic surface instead of a wood fiber surface
 A heavy-duty, all-plastic foam board with high-impact litho-grade polystyrene surface and extruded

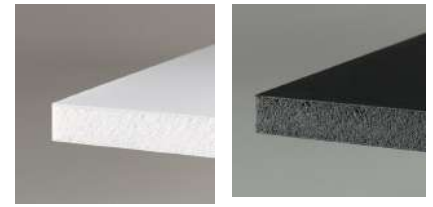

48" x 96" size sheet

White		White		Black	
3/16" 48"x96" White - 122.00	1" 48"x96" White - 269.00	3/16" 48"x96" Black - 135.00		1/2" 48"x96" Black - 198.00	
1/2" 48"x96" White - 178.00	1 1/2" 48"x96" White - 337.00	1/2" 48"x96" Black - 198.00		1" 48"x96" Black - 293.00	
3/4" 48"x96" White - 224.00	2" 48"x96" White - 412.00				

60" x 120" size sheet

White		White		Black	
3/16" 60"x120" White - 194.00	1" 60"x120" White - 419.00	1/2" 60"x120" Black - 299.00			
1/2" 60"x120" White - 281.50					
3/4" 60"x120" White - 359.00					

H.I.P.S. (High impact polystyrene)

HIGH IMPACT POLYSTYRENE - WHITE OPAQUE
 A low cost, tough plastic material that is often used for: retail display applications, indoor signs, & POP displays. Can be screen printed, UV Flatbed printed, or decorated with vinyl graphics.

	.010	.020	.030	.040	.060	.080	.100	.125
48"x 96"	10.50	17.40	23.95	32.50	52.00	60.80	quote	quote
Translucent White HIPS - .0175 thick - 49" x 74" - 12.95 sheet								

Translucent White HIPS - used extensively for background transparencies. Available in .0175 gauge.

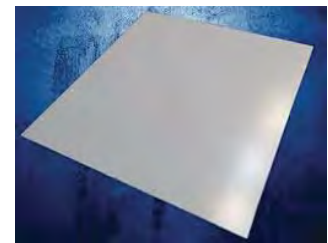

POLYCARBONATE FILM

SHEETS - 24" x 48"- priced per sheet

POLYCARBONATE (LEXAN TYPE)
 These films are both decorative and functionally versatile. The wide choice of surface textures provides optimal flexibility in graphic design with a bold contemporary look. Excellent for highly abrasion resistant name-plates and membrane switch overlays.

Type	1-49sheets	50 sheets	175 sheets (case)
.010 Polished Clear	8.95	7.90	7.35
.010 Velvet Matte	7.50	6.95	5.95

Type	1-24 sheets	25 sheets	100 sheets (case)
.020 Polished Clear	15.95	14.85	13.65
.020 Velvet Matte	13.95	12.80	11.20



Note: Also available in 48" width rolls in 25 ft., 50ft. and 100 ft. lengths. Check for price

Tyvek

TYVEK Dupont's durable sheet product has tough tear and water resistance for outdoor durability. If screen printing check for proper screen inks.

Tyvek Type 8740D - .0075 mil	
Roll Size	Roll Price
60" wide x 100 yds.	867.00



GLOSS VINYL SHEETS-White

GLOSSY 2-SIDED RIGID VINYL White
 A rigid vinyl sheet with high impact strength. Economical in price and ideal for signs, displays, vacuum formed parts, templates, calculating instruments, etc.

	.010	.020
OPAQUE WHITE 25" X 52"	5.40	
OPAQUE WHITE 44" X 52"		21.50



APPLICATOR SYRINGE

For applying methylene chloride and other solvent cements to: Acrylic, Plexiglas, Lucite, and Acrylite.
 1/2 oz. squeeze bottle with 27 ga. needle. **7.95ea.**



PLEXIGLAS ACRYLIC

Priced on size, gauge, and specifications. Ask for a price.

PETG SHEET

Priced on size, gauge, and specifications. Ask for a price.

A.B.S.

Priced on size, gauge, and specifications. Ask for a price.



CC500 GLOSS 3 mil Permanent Opaque Vinyl

A 3mil pressure sensitive polished polymeric flexible calendered vinyl w/permanent adhesive.

This product is recommended for outdoor and indoor uses where a high quality marking film is required, that has flexibility, durability, and resistance to sunlight.





























Expected lifetime exterior color fade is 5 yrs. under normal exposure conditions.

This material can be printed with high quality screen printing inks formulated for flexible vinyls.

PRICES

WIDTH	1-9 yds.	10 yds.	50yds (ROLL)	WIDTH	1-9 yds.	10 yds.	50yds. (ROLL)
15"perf.	3.05 yd.	2.70 yd.	2.25 yd. 112.50	36"	7.80yd.	7.15yd.	5.60yd. 280.50
20"	4.45 yd.	4.20yd.	3.65 yd. 182.50	45"	9.50 yd.	8.80 yd.	6.90 yd. 343.75
24"	4.45 yd.	4.20 yd.	3.65 yd. 182.50	48"	11.15yd.	10.50yd.	8.10 yd. 404.25
30"	6.35 yd.	5.75 yd.	4.60 yd. 230.00	60"	12.40yd.	11.45yd.	8.45yd. 423.50

Note-60" width is available only in those colors that are marked with an asterisk*

 1501* White "BLUE LINER"	 1511* Antique White	 1522 Dark Yellow	 1540 Hot Pink
 1500* Matte White	 1512 Victorian Blue	 1523 Lemon	 1541 Pink
 1502* Black	 1513 Ocean Blue	 1524* Daffodil	 1542 Coral
 1509* Matte Black	 1514 Arctic Blue	 1529 Mint	 1544 Orange
 1503* Transparent	 1515* Sky Blue	 1530 Brown	 1546* Purple
 1504* Matte Clear	 1516 Teal	 1531 Beige	 1548* Plum
 1505 Grey	 1517* Forest Green	 1534 Burgundy	 1549 Lavender
 1506 Midnight Blue	 1518 Dark Green	 1536 Cranberry	 1552 Lilac
 1507 Cobalt Blue	 1519* Green	 1537* Cherry Red	 1550* Gold
 1508* Sapphire Blue	 1520 Kelly Green	 1538* Tomato Red	 1551* Silver
 1510* Vivid Blue	 1521 Lime Green	 1539 Light Red	 1553 Rose Gold



KPMF 2 mil High Performance Cast Film



- Premium 2 mil opaque cast film with permanent acrylic adhesive.
- 8year outdoor durability, designed to meet or exceed OEM Spec.
- Apremium polycoated liner for ease of cutting,

LONG LIFE APPLICATIONS
HIGH PERFORMANCE - 2 mil. GLOSS

PRICE PER YARD

BLACK, WHITE, CLEAR			
WIDTH	1-9 YDS	10 YDS	55 YDS (Roll)
15" Punched	9.25	7.60	6.15
20" Non Punched	12.35	10.35	8.20
24" Non Punched	13.75	12.35	9.65
30" Non Punched	16.50	15.25	11.95
33" Non Punched	18.25	16.30	12.80
36" Non Punched	21.10	18.80	14.40
48" Non Punched	24.75	23.15	17.60
60" Non Punched	33.10	30.05	22.40

COLOURS			
WIDTH	1-9 YDS	10 YDS	55 YDS (Roll)
15" Punched	9.65	8.60	6.80
20" Non Punched	13.75	12.45	9.95
24" Non Punched	15.10	13.25	10.80
30" Non Punched	18.65	15.90	13.00
33" Non Punched	19.85	17.50	14.30
48" Non Punched	26.95	25.05	19.85
60" Non Punched	34.75	31.65	25.00

711 Gloss White	756 - Dark Red	731 - Sunflower Yellow	7620 - Teal	7623 - Brit Blue
7113 Arctic White				
7127 Matte White				
712 - Almond	7519 - Deep Red	7322 - H.O. Lemon	765 - Dark Aqua	7619 -Navy
7112 - Dove Grey	753 - Cardinal Red	774 - Lime Green	776 - Turquoise	7549 -Royal Purple
7116 - Signal Grey	759 - Pillar Box Red	7714 - Light Apple Green	7715 - Light Aqua	7511 -Violet
7111 - Mercury Grey	751 - Tomato Red	7713 - Apple Green	7613 - Light Blue	7614 - Lavender
713 - Light Grey	757 - Mid Red	7731 - Vivid Green	763 - Olympic Blue	7516 -Deep Purple
714 - Medium Grey	744 - Orange Red	771 - Kelly Green	7610 - Intense Blue	7548 - Raspberry
715 - Dark Grey	748 - Dark Orange	7716 - Green	761 - Vivid Blue	7524 -Dark Magenta
7125 - Nimbus Grey	741 - Orange	7730 - Bright Green	766 - Brilliant Blue	7525 - Magenta
721Gloss Black	7310 - Imitation Gold	772 - Forest	764 - Sapphire Blue	787 -Camel
722MatteBlack				
701 Gloss Clear	735 - Melon	775 - Deep Forest	7617 Viking Blue	783 -Brown
706 Matte Clear				
754 - Burgundy	736 - Buttercup	7732 - Traffic Green	7626 - Midnight Blue	781 Chocolate



METALLICS - PREMIUM CAST VINYL

STANDARD METALLICS

KPMF Metallics

Premium 2 mil metallic cast film with permanent acrylic adhesive.
 Designed for automotive and architectural design.
 Up to 10 yr. outdoor durability.
 Contact us for a SMF colour card.

Standard Metallics - Prices per yard

WIDTH	1 to 9 yds.	10to 49yds.	55 yds.(roll)
15"	12.75yd.	10.40yd.	8.20yd.
20"	18.75yd.	15.40yd.	11.35yd.
24"	19.40yd.	16.10yd.	12.40yd.
30"	24.50 yd.	20.05yd.	14.65yd.
48"	36.05yd.	29.30yd.	22.45yd.

Metallics

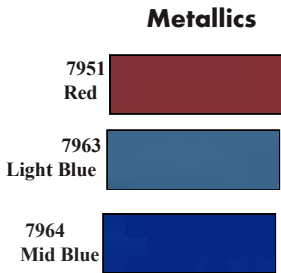

Glitters

SMF's Glitter series is a 4 mil cast "sparkly" vinyl suitable for use in exterior marking and signage applications. It has up to a 10 year outdoor durability. It has been developed by KPMF in the U.K. for Select Marking Films.

This line of vinyl is designed for use in decorative decals and eye catching graphics. It is excellent for use in marine and automotive applications.

Due to variances in computer monitor displays, colours shown are only our best representation. For true colour match, please email or phone for a copy of our SMF colour guide.



75158 - Silver Glitter



75159 - Gold Glitter



75150 - Black Glitter



75151 - Red Glitter



75152 - Pink Glitter



75153 - Forest Green



75155 - Royal Blue Glitter



75156 - Dark Blue Glitter



75157 - Lilac Glitter



75154 - Turquoise Glitter

GLITTER PRICES - per yard

WIDTH	1 to 9 yds.	10 yds.	55 yds. (full roll)
24"	23.70 yd.	19.85 yd.	16.15 yd. 888.25
48"	46.65 yd.	39.65 yd.	31.70 yd. 1743.20



2.6 mil Platinum Calendered Vinyl

SMF's 2.6 mil Platinum Calendered series is manufactured by Ritrama in Italy. This new line is an extremely high quality product suitable for use on smooth, textured and contoured surfaces. SMF films can be used for vehicle lettering to point of sale advertising, from outdoor signage to interior decoration. It is manufactured with a solvent-based adhesive, and mounted on a kraft liner, designed for trouble-free plotter cutting and installations.

804 - Pastel Yellow	806 - Bright Yellow	807 - Sun Yellow	808 - Dark Yellow	810 - Light Orange	811 - Orange
812 - Carrot	814 - Vivid Red	817 - Medium Red	818 - Dark Red	819 - Red	820 - Wine Red
821 - Burgundy	822 - Rioja Red	823 Process Magenta	824 - Plum	826 - Violet	827 - Midnight Blue
829 - Old Blue	830 Dark Blue	833 Ultramarine Blue	834 - Reflex Blue	835 - Cosmos Blue	836-Permanent Blue
837 - Medium Blue	839-Olympic Blue	840 - Light Blue	843 - Dark Lagoon	844 - Forest Green	846 - Freedom Green
848 - Bright Green	849 - Grass Green	850 - Apple Green	851 - Yellow Green	852 - Light Beige	853 Chocolate Brown
801 - Gloss Black	855 - Mystic Grey	857 - Traffic Grey	858 - Dark Grey	860 - Slate Grey	868 - Light Grey
862 - Pearl Grey	800 - Gloss White	899 - Gloss Clear	803 - Matte Black	865 Matte Anthracite Metallic	866 - Matte Silver Metallic
867 - Matte Copper Metallic	802 - Matte White	898 - Matte Clear	<p>Whites and clears have an outdoor durability of up to 10 years The colours have an outdoor durability of up to 8 years Metallic colours have an outdoor durability of up to 5 years</p>		

White Black & Clear	price per yard	15"	24"	48"
	1-9 yards	\$5.15	\$7.75	\$15.50
	10-54 yards	\$4.50	\$6.80	\$13.55
	55- yards (roll)	\$3.25	\$4.85	\$9.70

Colours	price per yard	15"	24"	48"
	1-9 yards	\$5.60	\$8.40	\$16.80
	10-26 yards	\$4.60	\$7.05	\$13.95
	27- yards (roll)	\$3.90	\$5.90	\$11.70

Metallics	price per yard	15"	24"	48"
	1-9 yards	\$6.40	\$9.65	\$19.25
	10-26 yards	\$5.35	\$8.05	\$16.05
	27- yards (roll)	\$4.45	\$6.70	\$13.45

Special Effect Film 24" wide

ASK FOR OUR FREE COLOR SWATCH BOOK FOR COLORS SHOWN BELOW

SMF's Special Effect Film line is a line of metalized vinyl films. These films print beautifully when using thermal transfer ribbons, screen inks, or solvent/eco-solvent inks. These Special Effect Films have an outdoor durability of up to 5 years.

Due to variances in computer monitor displays, colours shown are only our best representation.

For true colour match, please email or phone for a copy of our SMF colour guide.

Digital Print Film

<p>smooth mirror gold</p> <p>1-9 yds. - 30.85 yd. 10 yds. - 26.70 yd. 50 yds. - 27.95 yd.</p>	<p>smooth mirror silver</p> <p>1-9 yds. - 26.95 yd. 10 yds. - 23.40 yd. 50 yds. - 18.95 yd.</p>	<p>Brushed gold</p> <p>1-9 yds. - 38.75 yd. 10 yds. - 33.40 yd. 50 yds. - 27.50 yd.</p>	<p>Brushed silver</p> <p>1-9 yds. - 32.95 yd. 10 yds. - 28.35 yd. 50 yds. - 23.50 yd.</p>	<p>Diamond Plate silver</p> <p>1-9 yds. - 32.95 yd. 10 yds. - 28.35 yd. 50 yds. - 23.50 yd.</p>
<p>smooth mirror copper</p> <p>1-9 yds. - 30.85 yd. 10 yds. - 26.70 yd. 50 yds. - 27.95 yd.</p>	<p>Brushed copper</p> <p>1-9 yds. - 38.75 yd. 10 yds. - 33.40 yd. 50 yds. - 27.50 yd.</p>	<p>Engine turn large gold</p> <p>1-9 yds. - 38.75 yd. 10 yds. - 33.40 yd. 50 yds. - 27.50 yd.</p>	<p>Florentine gold</p> <p>1-9 yds. - 38.75 yd. 10 yds. - 33.40 yd. 50 yds. - 27.50 yd.</p>	<p>Hammered gold</p> <p>1-9 yds. - 38.75 yd. 10 yds. - 33.40 yd. 50 yds. - 27.50 yd.</p>
<p>Coarse Brushed gold</p> <p>1-9 yds. - 38.75 yd. 10 yds. - 33.40 yd. 50 yds. - 27.50 yd.</p>	<p>Coarse Brushed silver</p> <p>1-9 yds. - 32.95 yd. 10 yds. - 28.35 yd. 50 yds. - 23.50 yd.</p>	<p>Rainbow sparkle gold</p> <p>1-9 yds. - 38.75 yd. 10 yds. - 33.40 yd. 50 yds. - 27.50 yd.</p>	<p>Rainbow sparkle silver</p> <p>1-9 yds. - 38.75 yd. 10 yds. - 33.40 yd. 50 yds. - 27.50 yd.</p>	<p>Rainbow sequins silver</p> <p>1-9 yds. - 38.75 yd. 10 yds. - 33.40 yd. 50 yds. - 27.50 yd.</p>
<p>Rainbow brite gold</p> <p>1-9 yds. - 38.75 yd. 10 yds. - 33.40 yd. 50 yds. - 27.50 yd.</p>	<p>Rainbow brite silver</p> <p>1-9 yds. - 38.75 yd. 10 yds. - 33.40 yd. 50 yds. - 27.50 yd.</p>	<p>Rainbow brite pink</p> <p>1-9 yds. - 38.75 yd. 10 yds. - 33.40 yd. 50 yds. - 27.50 yd.</p>	<p>Rainbow brite gunmetal</p> <p>1-9 yds. - 38.75 yd. 10 yds. - 33.40 yd. 50 yds. - 27.50 yd.</p>	<p>Carbon fibre gunmetal</p> <p>1-9 yds. - 38.75 yd. 10 yds. - 33.40 yd. 50 yds. - 27.50 yd.</p>
<p>Engine turn small gold</p> <p>1-9 yds. - 38.75 yd. 10 yds. - 33.40 yd. 50 yds. - 27.50 yd.</p>	<p>Florentine silver</p> <p>1-9 yds. - 32.95 yd. 10 yds. - 28.35 yd. 50 yds. - 23.50 yd.</p>	<p>Engine turn large silver</p> <p>1-9 yds. - 32.95 yd. 10 yds. - 28.35 yd. 50 yds. - 23.50 yd.</p>	<p>Engine turn small silver</p> <p>1-9 yds. - 32.95 yd. 10 yds. - 28.35 yd. 50 yds. - 23.50 yd.</p>	<p>All films are 2.7mil calendered vinyl</p> <p>Up to 5 yr. outdoor durability</p> <p>Color card with swatches available on request.</p>



METALLIZED POLYESTERS

METALLIZED POLYESTERS

Custom films with the brilliance and lustre of true metal foils and the handling and workability of vinyl. These films are designed to accept a variety of solvent and u/v screen inks. Pre-testing is recommended. Good for indoor and short term outdoor applications. A high tack premask is recommended.

metallized polyesters price per yard price per yard			
SMF - 1-1/2 MIL - BRT. SILVER - BRT. GOLD - BRUSHED SILVER			
	#2070	#1076	#2072
WIDTH	1-9 YDS	10 YDS	50 YDS
15" Punched	9.45	7.55	6.05
20" Non Punched	12.90	11.15	9.00
24" Non Punched	14.55	12.10	9.55
30" Non Punched	19.00	15.10	11.90
48" Non Punched	28.05	22.45	18.15
54" Non Punched	30.60	24.35	20.20

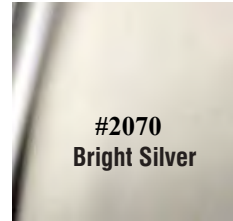

#2070
Bright Silver

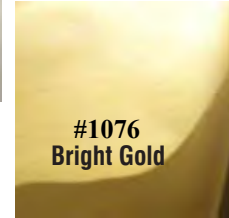

#1076
Bright Gold



#2072
Brushed Silver

metallized polyesters #1072 SMF 2 MIL BRUSHED GOLD POLYESTER price per yard			
WIDTH	1-9 YDS	10 YDS	50 YDS
15" Punched	9.95	7.95	6.50
20" Non Punched	15.00	11.90	9.70
24" Non Punched	15.85	12.70	10.20
30" Punched or Non Punched	1.35	15.10	11.85
48" Non Punched	28.35	22.55	18.10
54" Non Punched	31.35	24.40	19.60



#1072
Brushed Gold

HOLOGRAPHIC PRISMATIC FILM
 A METALLIZED light diffraction material depicting colours of the spectrum. 2.4 mil polyester.
 AVAILABLE IN: • SPARKLE #2016 • RAINBOW



HOLOGRAPHIC PRISMATIC PRICE PER YARD			
WIDTH	1-9 YDS	10 YDS	50 YDS
15" Punched	12.90	10.40	8.40
20" Non Punched	18.70	15.25	12.35
24" Non Punched	19.85	16.00	13.10
30" Punched or Non Punched	24.65	20.25	16.40
48" Non Punched	36.15	30.95	24.85



#2016
Prismatic
Sparkle



Prismatic
Rainbow



smooth chrome gold

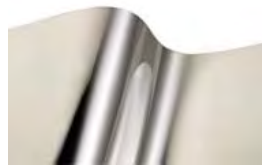

smooth chrome silver

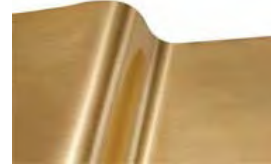

brushed gold



brushed silver



diamond plate silver

Outdoor Durability - up to 3 years

Our Vinylefx® Outdoor Durable Series, which provides up to three years of outdoor life, is comprised of a variety of cost-effective simulated metal, light-diffracting and 3-D patterns, designed for long-term outdoor signage. For demanding applications such as truck and boat graphics, the Vinylefx® Durable Series films provide a superior alternative to the expensive simulated gold-leaf films.

RTape Vinylefx® is exceptionally suited for general purpose signage applications and a cut above other “special effects” films thanks to a proprietary deep-embossing technology that provides a crisper three-dimensional appearance to each pattern. **Because the Vinylefx® is vinyl, not polyester, they require no top coating prior to printing!** They print, cut, weed and handle just like intermediate vinyl.

[click here to view color card, full specs, application guide, and tech information](#)

Vinyl Efx - Outdoor	24" WIDE			48" WIDE
	1-9 yds. per yd.	10 yd. roll	50 yd. roll	50 yd. rolls only
Smooth Chrome Silver	23.95	219.00	935.00	1797.00
Smooth Chrome Gold	26.95	235.00	1058.00	2030.00
Brushed Silver	26.95	235.00	1058.00	2030.00
Brushed Gold	31.00	275.00	1244.00	2390.00
Diamond Plate Silver	26.95	235.00	1058.00	2030.00



Print compatability:
 solvent - eco-solvent,
 latex,
 uv inkjet,
 screen printing

SMF 4mil Matte Calendered Fluorescent Vinyl

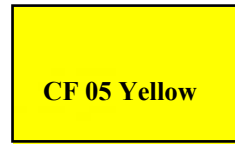

Used to produce promotional and safety graphics accented with a high level of decorative visibility. Designed for short-term applications with up to 6 months exterior exposure based on vertical applications and amount of UV exposure.



SMF Calendered fluorescent Vinyl - per yard				
WIDTH	1 to 9 yds.	10 yds.	55 yds. (full roll)	
24"	17.50 yd.	14.00 yd.	11.40 yd.	627.00
48"	32.80 yd.	27.25 yd.	22.00 yd.	1210.00

SMF GLOSS CAST FLUORESCENT 2 MIL GLOSS VINYL

With up to 2 yr. outdoor durability it is one of the longest lasting fluorescent films in the world. Used to produce promotional and safety graphics accented with a high level of decorative visibility.



SMF Cast fluorescent Gloss Vinyl - per yard				
WIDTH	1 to 9 yds.	10 yds.	55 yds. (full roll)	
24"	25.50 yd.	21.20 yd.	16.80 yd.	924.00
48"	49.85 yd.	41.50 yd.	32.55 yd.	1790.25

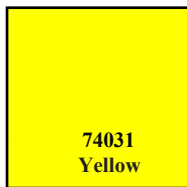

SMF 3.4 mil Premium Calendered Translucent Vinyl

SMF's Translucent series is a 3.4mil premium calendered vinyl suitable for use in all types of backlit signage applications. The vinyl is extremely conformable which makes it suitable for use on smooth, textured and contoured surfaces. All colours have up to a 5 year durability, with many having a durability of up to 7 years.

TRANSLUCENT COLOUR LIST

600 White Translucent	606 Light Yellow	612 Bright Yellow	610 Yellow	620 Orange	629 Light Red	627 Medium Red
630 Red	689 Magenta	652 Dark Purple	645 Brown	658 Olympic Blue	650 Blue	653 Dark Blue
640 Violet	667 Light Green	670 Green	683 Forest Green	604 Light Grey	605 Dark Grey	601 Black Translucent
673 Grass Green	679 Lime Green	674 Meadow Green	677 Turquoise	678 Cyan	680 Signal Blue	675 Ultra Marine
671 Silver	672 Gold	676 Bordeaux				

SMF Translucent Calendered Vinyl - per yard				
WIDTH	1 to 9 yds.	10 yds.	55 yds. (full roll)	
24"	13.15 yd.	10.95 yd.	9.45 yd.	519.75
48"	25.00 yd.	21.45 yd.	18.00 yd.	990.00



WINDOW GLASS ETCH

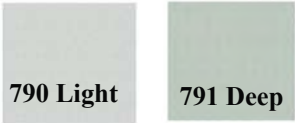

FROSTED/ETCH GLASS



GF- ETCH #790 Light Etch - #791 Deep Etch

3.0 mil Polymeric vinyl - - up to 7 yr.durability

Width	1-9yds.	10yds.	50yds.
Price Per yard	Price Per yard	Price Per yard	Price Per yard
24"	12.35	11.35	10.15
30"	15.50	14.50	12.70
48"	22.50	21.50	19.65
60"	26.95	25.95	23.95

SMF BRAND - 2 mil CAST VINYL GLASS ETCH

11500 Frosted Etch- 11507 Etch Glass Green- up to 10 yr. durability

Width	1-9yds.	10yds.	55yds.
Price Per yard			
24"	18.90	15.60	12.40
36"	30.25	25.70	19.85
48"	37.40	29.40	23.60
60" (11500 only)	47.60	37.80	31.50

SMF BRAND - 2.8 mil Calendered Vinyl Glass Etch
 15011 Silver - 15012 Textured Silver - 15031 Gold - up to 7 yr. ext.

Width	1-9yds.		10yds.		55yds.	
	Silver	Gold Text. Silver	Silver	Gold Text. Silver	Silver	Gold Text. Silver
Price Per yard						
24"	15.75	16.80	12.60	13.00	10.30	10.65
36"	23.85	26.00	18.90	21.50	12.60	15.75
48"	28.35	29.40	22.85	24.30	18.40	19.95
60"	36.20	n/a	28.00	n/a	24.55	n/a

SMF BRAND "CRYSTAL" Glass Etch - 2mil Cast Vinyl
 UP TO 12 YR. EXTERIOR DURABILITY

Numbers 11512 Crystal Silk & 11513 Crystal Sparkle

Width	1-9yds.		10yds.		55yds.	
	Silk	Sparkle	Silk	Sparkle	Silk	Sparkle
Price Per yard						
24"	20.40	35.15	17.00	26.00	13.65	21.50
36"	35.15	55.55	29.40	44.10	22.65	34.00
48"	39.70	62.35	32.85	52.10	26.00	40.75
60"	52.10	n/a	44.10	n/a	32.85	n/a

790AE NEW **Print-n-Privacy** 7 yr / -
PRINT-n-PRIVACY™
 3.0 mil - Polymeric Glass Etch Film (Light)
 Clear Solvent Permanent Adhesive
 90# Paper Air Egress Liner
 (Dry Apply Only)

Rolls only

790AE-54 54"x75' 570.00 1.69sq.ft.

Printable w/Solvent, Latex or UV



SMF 3 MIL CALENDERED TRANSPARENT FILM

These Transparent coloured vinyls are designed for backlit signage, window graphics and colour change overlaminating use. While not optically clear, they are designed for glass decorations and light boxes. The film is a monomeric calendered vinyl with a gloss finish. They come with a liner that offers superior cuttability with conventional die-cutting and computer sign making systems. 3 to 5 yr. outdoor durability based on normal exterior conditions.



SMF Calendered Transparent Vinyl - per yard

WIDTH	1 to 9 yds.	10 yds.	55 yds. (full roll)
24"	9.90yd.	8.20yd.	6.95 yd. 382.25
48"	18.65 yd.	15.75 yd.	13.45 yd. 739.75



DRY ERASE FILMS - Luminescent Film

Carbon Fibre Black Film - Conspicuity Film



DRY ERASE FILM



Write / on wipe/off clear pressure sensitive overlaminates
 . Designed for use with dry erase markers
 . Recommended for flat applications



Clear Laminate

G/F BRAND - DRY ERASE FILM #111 Clear - price per yd.

WIDTH	1-9 YDS	10 YDS	50 YDS
54" only	9.60yd.	8.50yd.	6.78yd. (roll 339.00)

SMF BRAND - DRY ERASE FILM - price per yard

WIDTH	1-24 YDS	25 YDS	50 YDS
15" Punched	3.75	2.75	2.20
24" Non-Punched	6.15	4.70	3.55
30" Non-Punched	7.40	5.60	4.35
48" Non-Punched	12.95	9.75	7.50
60" Non-Punched	14.95	11.00	8.50

G/F BRAND - ERASE MARK PRO #110 Clear - price per yd.
 Size 54"x50 yd. rolls only - 719.00 roll

2 mil Commercial Grade Dry Erase Laminate
 Engineered for ong-term dry erase applications
 Resistant to permanent & semi-permanent markers
 5 year indoor durability with proper care & cleaning
 For use in hospitals, Restaurants, Retail & Schools



Luminescent Film

Luminescent Film



This premium quality cast vinyl is designed for use in all emergency sign and marking applications. It has the ultimate properties for outdoor graphic or emergency equipment and exit signs.

1 Hour Luminosity Life after exposure to artificial or outdoor light

The vinyl is very conformable and can be used on smooth, textured, and contoured surfaces. Printable by digital and screen process

GLOW IN THE DARK WHITE

GLOW IN THE DARK YELLOW

premium cast vinyl
 5mil - up to 10 year exterior exposure

premium cast vinyl
 5mil - up to 10 year exterior exposure

Priced per **FOOT**
 White or Yellow

Width	24"	48"
1-9 feet	23.60	43.30
10 feet	21.10	38.35
50+feet	17.35	32.90

CARBON FIBRE BLACK



6 mil calendared vinyl film with a clear re-positionable permanent acrylic adhesive on an air-egress liner.

60" WIDTH

1-9 ft..	- 25.85 foot
10-49 ft.	- 17.80 foot
50 ft.	- 14.45 foot

CONSPICUITY TAPE

- Compliant with Specification NHTSA 49 CFR/ part 571/DOT C-2
- 2" WR7-11 stripe (7" white/11" red)



PRICE PER YARD

WIDTH	1-9 YDS	10 YDS	50 YDS
2"	10.00	8.70	6.30

Graphic Commerce Ltd.

3M 7300 Reflective Series Engineer Grade

Better Reflectivity at a lower price. Yes, you read that right!
Offers greater visibility day or night.
Brighter commercial signs and traffic control signs, means graphics printed on white will draw even more attention



Available in White and Orange

Flexible for simple curve applications (not transportation) grade.
 Digitally printable. Compatible with screen, latex, UV, and solvent based inks.



impact resistant

Prices for White

Sold in 24" and 48" widths. Prices for White only			
24" wide	1-9yds. 15.40yd.	10 - 49yds 14.50yd.	50yds - 595.00
48" wide	1-9yds. 29.95yd.	10 - 49yds 27.95yd.	50yds - 1150.00

Prices for Orange

Sold in 24" and 48" widths. Prices for Orange only			
24" wide	1-9yds. 24.75yd.	10-49yds 20.70yd.	50yds-768.90
48" wide	1-9yds. 39.40yd.	10-49yds 37.20yd.	50yds-1362.90

KIWA REFLECTIVE - TRANSPORTATION GRADE

- Fleet grade 5.5 mil premium cast reflective film
- 7year outdoor durability meets OEM specs.
- Formulated for computer cut applications
- Designed for flat, corrugated, and irregular surfaces including rivets, with superior conforming characteristics
- Excellent results in screen and thermal printing applications

PRICE PER YARD			
WIDTH	1-9 YDS	10 YDS	50 YDS
15" Punched	26.25	20.90	17.65
20" Non Punched	38.60	31.90	25.20
24" Non Punched	40.75	33.00	28.00
30" Non Punched	51.80	38.60	34.00
48" Non Punched	76.00	63.95	51.75

COLOURS: 17013 White 17033 Lemon Yellow 17043 Yellow 17053 Orange

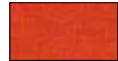

17063 Red



17163 Dark Red



17183 Lt. Blue



17083 Blue



17073 Green



17093 Black



MACtac®

REFLECTIVE



Features and uses:

- Easy to cut and weed.
- Vehicle markings.
- Very flexible and can be applied over rivets and corrugated surfaces.

5700 is a flexible reflective film (Engineering Grade) providing wide-angle reflectivity of incident light and giving excellent night and day visibility. The face is made with a layer of microscopic glass beads of a high optical quality. These are embedded into a colored film, which then act as a lens. A metallized back provides the mirrored surface for reflection. The film is coated with a **white, high strength, permanent, acrylic adhesive**. A 92# white polycoated paper liner offers stability and excellent layflat qualities.

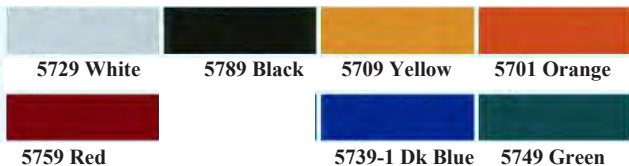

PRICE PER YARD

WIDTH	1-9 YDS	10 YDS	50 YDS (Roll)
White - 24"	27.75	25.95	23.50 (1175.00)
White - 48"	53.90	48.50	44.50 (2225.00)
Colors- 24"	32.75	30.95	27.95 (1397.50)
Colors- 48"	64.50	61.90	44.50 (2225.00)

APPLICATION FLUIDS- ADHESIVE REMOVERS



RAPID TAC OR RAPID TAC II

For "wet" applications • Rapid Tac II for other than Premium Vinyls.



1. Thoroughly clean panels with Rapid Tac and kitchen paper towel. Do not use other cleaners or solvents nor cloth towels or commercial paper towels.



2. Spray panels again with Rapid Tac. Peel backing off decal and place on wet panel. You may also spray adhesive side of decal (See fig. 2)



3. Align decal. Use the squeegee to remove fluid, using a good deal of pressure and working from the center out toward the edges in all directions. (See fig. 3)



4. Wait 2-3 minutes. If decal has cover tape saturate it with Rapid Tac, then remove the tape. Wipe with paper towel and your application is complete. (See fig. 4)



[click here for demonstrations](#)

RAPIDTAC APPLICATION FLUID is a "super-wet" liquid which cleans the substrate surface and makes the application of even the largest of pressure sensitive markings simple, allowing the correct positioning before final placement.



32oz. with sprayer - 18.40
128 oz. (gallon) without sprayer - 51.20

RAPIDTAC APPLICATION FLUID II

RAPID TAC APPLICATION FLUID II - has the same benefits as RAPIDTAC, but also allows wet application of polyesters, reflectives, and metallized films. Improves bonding on economy type vinyls

32 oz. with sprayer - 24.55
128 oz. w/o sprayer - 68.95



RAPIDTAC ADHESIVE REMOVER

RAPIDTAC WATER SOLUBLE ADHESIVE REMOVER removes glue left on surface after removing decals or film. Works on painted surfaces, some plastics and other surfaces. Not recommended for anodized finishes.

32 oz. with sprayer - 42.60
128oz (gal.)w/o sprayer-113.00

Remove most adhesives in 30 to 60 seconds!
Scoop off adhesive in 60 seconds like shovelling snow!



RAPIDPREP

RAPID Prep is a water-based nonflammable wash solvent for preparing surfaces for painting. Totally removes silicone, wax, grease, and oil safely. Especially useful on plastic auto parts.

32 oz. with sprayer - 19.80
128 oz. w/o sprayer - 53.00



RAPID CLEAR

Cleans and polishes any transparent material eg. glass, Lexan, Plexiglass, most Polycarbonates, and leaves a professional lustre. Also does an excellent job on non transparent surfaces.

Use as a final cleaning for sign work.
32 oz. w/sprayer - 15.25
128 oz. w/o sprayer 41.00



RAPID REMOVER

Adhesive remover,
works in 60 seconds.



1. Remove decal with heat lamp or heat gun.



2. Now spray glue residue with Rapid Remover and let it penetrate for 30-60 seconds.



3. Using squeegee, scrape to remove glue residue.



4. Now spray Rapid Remover on rag or paper towel and wipe area clean.
5. Thoroughly rinse area with Rapid Tac or Rapid Tac II

RECOMMENDATION:

DO NOT clean any substrate with glass cleaners, paint solvents, (prep-sol, pre-cleto, etc.). Just clean substrate with: Rapid Tac Application Fluid, Rapid Tac II Application Fluid, or for stubborn jobs like silicone, wax, grease or oil, clean with Rapid Prep. All 3 products were built to clean leaving no contaminating residue.

DO USE kitchen type paper towels and Rapid Tac products to clean prior to application of vinyl or films ONLY!

Graphic Commerce Ltd.

SQUEEGEE APPLICATORS FOR VINYL INSTALLATIONS

Saves time ! Saves money ! Saves Fatigue ! Assures a better application !

"Easy Glide" SQUEEGEES



GC 4" (w/built in ruler) 4" wide - 1.15 ea.



w/soft felt pad on one side and teflon strip on the other. - 6.50 ea.



Same 5" Squeegee without the felt and teflon - 2.10 ea.



MACTAC FELT 4" - 5.95 ea.



3M GOLD 4"- 7.25 ea.



SIGNAL ORANGE 3.5" - .69 ea.

BIG BLADE INDIGO - FLEXIBLE 4"



Removes graphics, preventing scratches. Double edged Flexible Chemically resistant. - 1.49 ea.



RC6 - Blue 6" Squeegee - 3.85 ea.

APPLICATOR TOOLS FOR VINYL - CONTINUED.

Excel Hook-on Weeding Tool w/cap
detaches adhesive materials from surfaces
13.75 ea.



cushion grip for comfort

Excel Weeding Tool w/cap - Awl needle Point
used for weeding and vinyl bubble air release
6.30 ea.



Excel Weeding Tool w/cap and 4 extra blades



9.95 ea.

Replacement needles only for Excel
needle point weeder.

Pkg. of 5 - 4.95



Excel Tweezers



For accurate control in sorting, probing, and
precision work. Needle sharp - Light tension.
Surgical steel.



Curved Point Tweezers - 6" - 7.70 ea.



Sharp Point Tweezers - 4 3/4" - 7.70 ea.



RIVET BRUSH

Size 1-1/2"-12.75

A stiff-bristled nylon brush is
used to burnish vinyl film onto
the heads of truck rivets, curves
and large textured areas.



1.49 ea.

Lift-Stick Adhesive Remover

This product is red in color and used to aid in the lifting of pressure
sensitive material and the removal of adhesive from surfaces. If used
correctly, it will not scratch the substrate. It is made of a special aircraft
plastic that makes it very durable. The 6" length is designed to prevent
hand fatigue when used continually during big jobs.

Speedball[®] SOFT BRAYERS

Made from pure gum natural rubber with a ground
finish. 20 durometer hardness. Heavy duty steel
frame. Package contains craft tip usage guide.

Speedball[®] HARD BRAYERS

Hard rubber roller made from synthetic
rubber (80 durometer). Available in 4 inch
width only.

Speedball[®] ACRYLIC BRAYER

4" Clear Acrylic Brayer Roller is
interchangeable in a 1 piece sturdy
plastic frame.



Deluxe
model soft



**WITH STURDY 1 PIECE
PLASTIC FRAME FOR
POP-IN REPLACEABLE
ROLLERS**

#4117 - 4" w/ roller 20.60 ea.
#4187 - 4" roller only 15.95



Deluxe model
hard

WITH METAL FRAME

#4121 - 4" - 22.50 ea.



hard

**WITH PLASTIC 1 PIECE
FRAME FOR POP-IN
REPLACEMENT
ROLLERS**

#4128 - 4" w/roller - 15.65ea.
#4186 - 4" roller only 9.45ea



hard

WITH PLASTIC 1 PIECE FRAME

#41234- 4" acrylic brayer - 28.80 ea.
#4184 - 4" acrylic roller only-18.40ea.



Magnets for Vehicle Wraps

Extra - Strong

for easy positioning of vehicle graphics
during installation.

9.00 ea.





Excel Knives - Blades - Tools

Excel K1 Aluminum Knife w/ #11 blade & safety cap



5.25

Light weight body fits with all standard craft knife blades including Xacto Knife. Includes 4 jaw aluminum chuck for more secure blade positioning and hold than your standard light duty knife; with a snug fitting, twist lock safety cap.

Excel #11 Blades

Sharper than average, these double honed blades are made from carbon steel and have a strong tip and flex without breaking, keeping their edge and tip longer, and are coated in a thin layer of oil for rust protection. Pkg. of 5 - 3.25 - Pkg. of 100 - 53.00



sword point



Excel #16 Blades

Sharper than average, these double honed blades are made from carbon steel and have a strong tip and flex without breaking, keeping their edge and tip longer, and are coated in a thin layer of oil for rust protection. Dispenser Pack of 15 - 10.95 Pkg. of 100 - 45.00



chisel point



K-18 Soft Grip Knife w/1 #11 blade



Light weight, aluminum body with comfortable **soft grip handle**. Fits all standard craft knife blades including Xacto Knife. Includes 4 jaw aluminum chuck with rear blade release for a more secure blade and hold than your standard light duty knife. Comes with a snug fitting twist lock safety cap



color blue

8.95

w/1 no. 11 blade

10.95ea.



Excel K26 Fit Grip Knife w/ #11 blade

Unique like no other, the K26 knife has a rubberized soft ergonomic handle for long time use. It encases a strong aluminum body and four jawed chuck with rear blade release for a more secure blade placement. Includes a #11 blade and a snug fitting, shatter resistant safety cap



Excel K71 Index Knife w/ #11 blade 6.95

The Index Detail Knife is a small, lightweight, maneuverable knife designed with a oval-like hole handle to hug the users index finger while in use. This enables the user the maximum amount of control without losing any of the comfort.

Excel Swivel Knife 10.25



for precision cutting, trimming, and stripping of paper, plastic, wood, cloth, and film. Textured grip for ease of use.

Replacement Blade for Excel Swivel knife #64 blade - pkg.2 - 3.75 pkg.



Mahl Stick

A necessity if painting fine details is important to your work. This 30" inch mahl stick is used to keep a steady hand at close proximity to your project. It includes 3 ten inch sections that screw into each other, perfect for tight storage or travel. Rubber tip is used to protect artwork.

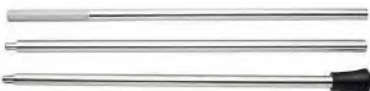

25.25

Excel Pounce Wheels



The versatile head can be locked for straight line work or loose to allow for circles or curved designs, 12.95ea.

OLFA Cutters and Knives

WITH AUTO-LOCK AND BLADE DISPOSAL CASE

OLFA MODEL A

Ideal for draftsmen, artwork, decorators, Click-stop action. 13 Snap-off points

Model A Knife 7.10



AB50B Blades-Regular Pk.50-22.70 - AB10B Pk.10 -5.95
ABB50B Carbon Blades-Pk.50-26.10- ABB10B Pk.10-7.35
AB50S Stainless Steel-Pk.50-31.75 AB10S Pk 10-8.35

OLFA MODEL L-1

Heavy duty carton opener also cuts vinyl sheets and leather. Set screw secures blades. 24 snap-off points.

L-1 Knife - 10.65



LB 10 B	Blades - Standard Pkg.	7.90
10 LBB10B	Blades - Carbon	30.70
		34.95

OLFA MODEL L-2

Utility Knife with Rubber Grip. A non-slip rubber grip fits comfortably and securely in the hand. Set screw secures blades.



L-2 Knife - 12.25

LB 10 B	Blades - Standard	7.90
Pkg. 10 LBB10B	Blades - Carbon	30.70
		34.95



OLFA ART KNIFE AK-1 AK-1 Knife 7.25

For fine art work. Comes with 5 blades.

KB Blades - Pkg. 25 - 5.95

OLFA SILVER - Model: SVR 2 - 10.35



Standard type snap-off blade cutter. Stainless steel holder is tough and durable. The good looking slim body assures a positive grip. (With 2 extra blades).

AB 10 B Blades - Pkg. 10- 5.95
AB 50 B Blades - Pkg.50 22.70
ABB 50B Carbon Blades-50 26.10

STAINLESS RUST-RESISTANT KNIFE

OLFA STAINLESS STEEL SNAP-OFF GRAPHICS KNIFE - MODEL SAC-1



11.95

Ultra thin cutter is the tool of choice for graphic artists and sign making professionals. The acute 30 degree angle blades easily cuts cardboard, plastics and foam boards. Features an auto lock, pocket clip and blade snapper.

A1160B Snap Off Blades for SAC-1 KNIFE - 10.35 Pkg.10



OLFA COMPASS CUTTER -CMP-1 - 11.35

Cuts precise circles from 0.4" to 5.8" diameter. (1 to 15 cm.) Special rubber pad for preventing a pin hole.

COB-1 Blades - Pkg.-15 - 5.95

CUTTING TOOLS

CORO-CLAW™ Cutters



Coro Claw Deluxe 4 mil flute cutter - **26.25 ea.**
 replacement blade - 15.20 ea.



Coro Claw 10 Mil flute cutter - **51.00 ea.**
 replacement blade- 32.20ea.

[see videos-click here](#)

OLFA MODEL L-1

Our **Biddi Safety Knife** is used to cut banner material, vinyl, paper, film and most other thin and flexible material. Biddi is short for Bi Directional knife because you can cut forward and backwards with it. **21.95**

L-1 Knife - 10.65



LB 10 B	Blades - Standard Pkg.	7.90
10 LBB10B	Blades - Carbon	30.70
		34.95

replacement blades - 9.95 ea.



OLFA PLASTIC CUTTER PC-L

Heavy duty plastic/laminate cutter designed as a scoring tool for sheet plastic and laminates. Allows for the precise breaking of plastics. Ratchet wheel for secure blade extension, retraction, and positioning.



L-2 Knife - 12.25

LB 10 B	Blades - Standard	7.90
Pkg. 10 LBB10B	Blades - Carbon	30.70
		34.95

OLFA PLASTIC CUTTER PC-L

Heavy duty plastic/laminate cutter designed as a scoring tool for sheet plastic and laminates. Allows for the precise breaking of plastics. Ratchet wheel for secure blade extension, retraction, and positioning.



PC-L cutter (w/3 blades) **14.25**
 PB-800 blades (pkg.3) **5.95**



OLFA TS-1 TOP SHEET CUTTER

This new Top Sheet Cutter is a smartly engineered innovative tool that offers a unique way to cut only a single top sheet of material. Cuts newsprintpaper, cardstock, thin films, plastic sheeting, and tape. Blade storage is easily accessible in the handle of the knife.

TS-1 Cutter - 13.70 Blades-TSB-1 - 3.75 pkg./5

[click here for complete descriptive information](#)

OLFA SK-10 CONCEALED BLADE SAFETY KNIFE



Concealed blade safety knife featuring an adjustable blade positioning design which allows for 4 cutting points on a single-edge utility blade. Highly productive, it delivers 4x's more cuts than a single-edge, fixed blade "gooseneck" safety knife

SK-10 Knife - 13.65
 Blades - SKB-10B - 8.45 pkg./10

Retractable Razor Scraper Heavy Duty



- Metal Body-Brass Slider
- locks in 3 positions.
- Scrapes and cleans windows and other surfaces.
- Replaceable w/ a single edged razor blade. 4.50 ea.

Razor Scraper Blades



-single edge

-high carbon steel
 -precision ground
 PKG. 100 - 23.95



8" Super Sharp Scissors

Long lasting - Stainless steel
 Sharp blades for crisp cut
 Moulded handle for comfort grip.

5.95

Banner Material



Smooth Vinyl Finish with Tough, Interwoven Scrim

14 oz BANANA BANNER WITH Hems and Grommets

Gloss Colors **white black red blue yellow green**

with regular grommets

FINISHED WIDTH		Rolls - 24 yds
22"	22" x 24 yds.	137.00 roll
34"	34" x 24 yds.	183.00 roll
46"	46" x 24 yds.	225.00 roll

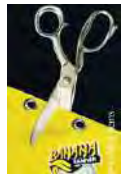

Double Grommet DESIGN
Eliminates Waste

Easy flat surface to work on

High Quality #2 spur nickel-plated double grommets are spaced every 24 inches apart.

Consistent Each roll is exactly the same in gloss, hems, and grommeting



PRE-GROMMETED READY TO PRINT DIGITAL BANNER by BANANA BANNER - with low profile grommets - for solvent ink jet printing



IMPORTANT - [click here to see video on printing instructions](#)

Roll Size	Roll Price
24" wide x 24 yds.	114.00
36" wide x 24 yds.	168.00
48" wide x 24 yds.	220.00



RM 054 CANVAS - 9oz. Cotton

RM 054 Canvas is a 9oz COTTON based Fine Art Canvas with a white acrylic coating for solvent, eco-solvent, latex and UV printing.

The high white point allows for deeply saturated colors when needed.

RM Canvas is the perfect Premium canvas media for printing of Artist wraps, larger photographs, pictures, giclée framing, pixel wraps, Image wraps, go framing, canvas paintings and art prints.

Picture Wrap Frames to be used are 1.25 or 1.75" in width with lengths ranging from 8" to 60"

Rolls - 54"x 82 ft.- 307.00 per roll Part roll- 14.95 per yd.



RM SOLVENT PAPER - 9 oz.

RM 9mil Gloss or Matte Solvent Paper is a brilliant choice for creating outstanding indoor signage, requiring high-resolution full-color prints. It is compatible with most Solvent, Eco-Solvent and Latex Printers. RM Solvent Paper is available in width of 54" x 100' long.

Applications include: Posters - Murals - Photo Enlargements - POP Displays. Durability- Short term

Rolls - Gloss or Matte - 54"x 100 ft.- 225.00 per roll



DIGITAL BANNER MATERIAL

13oz Single Sided Banner

13oz Scrim White banner - gloss white or matte white finish.
 Excellent for use in promotional indoor or outdoor applications.
 Compatible with most solvent, eco solvent, latex, and UVcurable inkjet printers .
 Easy finish/grommet, sewed and hem stitch capable.
 Abrasion resistant. Lightweight.
 Great for tradeshow displays outdoor or indoor signage.



38"x 164 ft. Gloss White (728894) or Matte White (728899) - ea. 128.95 roll
54"x 164 ft. Gloss White (728895) or Matte White (728900) - ea. 181.75 roll
63"x 164 ft. Gloss White (728896) or Matte White (728901) - ea. 212.50 roll
80"x 164 ft. Gloss White (728897) or Matte White (728902) - ea. 269.00 roll
98"x 164 ft. Gloss White (728898) or Matte White (728903) - ea. 330.00 roll
126"x 164 ft. Matte White (728904) - ea. 410.00 roll
150"x 164 ft. Matte White (728905) - ea. 627.00 roll
196"x 164 ft. Matte White (728906) - ea. 823.00 roll



13oz Double Sided Banner Opaque white - Vivid appearance

Smooth, opaque and flexible PVC banner with a polyester fabric embedded between two PVC vinyl layers. Gives images a vivid bright appearance.
 Drapes with ease and delivers high opacity to block back light and shadows. Quick drying, abrasion resistant and water-resistant.
 Compatible with most solvent, eco-solvent, latex and UV curable inkjet printers.
 Great for multiple applications: **indoor/outdoor signage/ building signs/ tradeshow displays, front-lit signage.**



38"x 164 ft. (728892) - 239.00 roll	54"x 164 ft. (728893) - 345.00 roll
63"x 164 ft. (730559) - 398.00 roll	98"x 164 ft. (730561) - 609.00 roll



10oz PET Grey Back FR Banner

10oz PET Grey Back Banner is made of PVC and PET composite. It is a non-curling banner with a super smooth surface. The grey back makes this banner opaque. It is suitable for solvent and eco-solvent ink; UV curable with good ink absorption, supplying a high-quality printing image with vivid and brilliant colours. This banner is for indoor applications only.



(RMBK001) 36"x 164 ft. Gloss White - ea. 211.00 roll
(RMBK002) 54"x 164 ft. Gloss White - ea. 306.00 roll

8 oz Mesh Banner with Liner Backing

8oz mesh banner with liner backing. Lightweight mesh material for windy area. Weave minimizes wind resistance and allows air to pass through the material Comes wound with a special backing material that is removed after printing



Size	Number	Price
54"x164 ft. (RMBM003)	8oz w/Liner	- 263.00
126"x164 ft. (RMBM006)	8oz w/Liner	- 587.00



2 Sides Available for Inserts
(Inserts not included in prices)

A-FRAMES TOP LOAD

48.95 41.50 54.00 41.00 48.95 49.90

A-203T Top Load A-218 Top Load A-232 Top Load A-108 Top Load A-2424 Top Load A-218V Top Load
24" w x 36" h insert size. 24" w x 18" h insert size. 32" w x 24" h insert size. 24" w x 32" h insert size. 24" w x 24" h insert size. 18" w x 24" h insert size.

A-FRAMES SIDE LOAD

77.00 67.00

A-324 Side Load A-204 Side Load
32" w x 48" h insert size. 24" w x 48" h insert size.

2 POST FRAMES

32" or 36" 24"

TWO POST FRAME TWO POST FRAME

2 Part Construction 1 Part Construction

Available in 2 sizes Available in 4 Insert Sizes

TPF 32W 73.65 TPF 36W 83.95

Insert Sizes are:
TPF-32W - 32"Wx24"H
TPF-36W - 36"Wx24"H

60" 48"

All sizes 42.50
Specify insert Size

TPF-1824 - 24"Wx18"H
TPF-2424 - 24"Wx24"H
TPF-2436 - 24"Wx36"H
TPF-2432 - 24"Wx32"H

A Board

"A" BOARD
DISPLAY AREA
24" X 34 3/4"

34 3/4" 24" 6"

111.00

MCA-2436

Steel construction, painted white. No additional inserts required. Excellent for use with magnetics. Just add graphics.

111.00

CRANE SIGN HOLDER

60"

→ C 24 - 24" w. ←
→ C 36 - 36" w. ←

C24-24x40" display area
holes 16" apart on center
C36-36x40" display area
holes 28" apart on center

Crane Sign Holder
No. C24 - \$44.65
No. C36 - \$66.75

STEP STAKES

10"

STEP STAKES
for corrugated plastic signs (not included)
Flexible rustproof steel wire construction.
Height - 30". Excellent for election signs, real estate, or any temporary lawn sign.
Available in singles or carrying case of 50
39.95 case/50 less then 50 - 1.00ea.

PRO-LINK

Attach Signs and billboards to chain-link fences.
Includes 1 bracket and 1 5/16"x1" bolt.
Price - 2.95
50-99- 2.35
100 - 2.15

4mm WHITE COROPLAST

Size	Price
24" x 18"	3.75
24" x 32"	5.20
24" x 36"	5.20

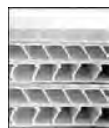

note flute directions

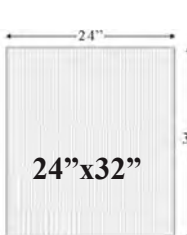
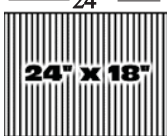

CHECK FOR PRICING ON OTHER SIZES

ALUMINUM SIGN BLANKS . .

051 Thick (16 ga.) coated white 2 sides

Size	w/square corners	w/round corners
12"x18"	15.50 ea.	16.50 ea.
18"x24"	29.95 ea.	30.95 ea.
24"x24"	43.90 ea.	44.90 ea.
24"x36"	64.95 ea.	65.95 ea.



140125

Hinge Handle

8.50ea.

11 1/2" Plastic w/steel insert

Hinge Handle

9.50ea.

15" Plastic w/steel insert



12" Aluminum Hinge Handle

Extra Strong

All metal design

13.50ea.

METAL SIGN HOLDERS



(insert not supplied)

WINDSPINNER

Total height: 39"
DISPLAY AREA:
18" X 30"

W-1836 159.00

Spins with ease.
Heavy duty 30" (diagonal) secure base.
Solid steel construction, can be used with a variety of substrates up to 1/2" thick (not included).
Pegs Included



Chrome Floor Stand
22x28"

ELEGANT AND HEAVY DUTY FLOOR STAND. 67" HEIGHT HOLDS 22"X28" GRAPHIC. STABLE 15" TRUMPET BASE CHROME FINISH.

CFS-2228
194.00

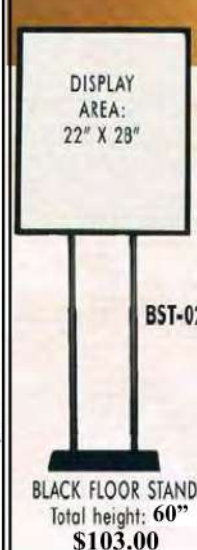

DISPLAY AREA:
22" X 28"

BST-022

BLACK FLOOR STAND
Total height: 60"
\$103.00

PORTABLE OUTDOOR SIGN HOLDER



24"
38"

ACM ALUMINUM COMPOSITE MATERIAL (3MM THICK)
JUST ADD GRAPHICS ON BOTH SIDES

POSH 203

MODERN FRAMELESS DESIGN

EXCELLENT OUTDOOR WEATHERABILITY

24"x36"
\$64.65

EASY AND QUICK ASSEMBLY



STURDY METAL BASE

FLOOR STANDS



X-Banner Stand - Only \$24.30
size - 23.5" x 63"
easy to useeffective



ALUMINUM EASEL
adjustable from 22 inches to 60 inches
WIDTH from 18" to 36". Black - 2.6 lbs.
Use as table top or floor model 35.20

Standoffs - 2.95 ea.



2"high 3/4"wide	1 1/4"high 3/4"wide	1"high 1"wide	1"high 1/2"wide
--------------------	------------------------	------------------	--------------------

ROLL UP DELUXE BANNER STAND

Look at these features :-

Telescopes from 63" to 86.6" Storage inside the base for:-

the pole and top bar

-and a knob to adjust tension on the graphic

Top panel profile clamps your media securely without need for adhesive strips.

Pole attaches to top panel from behind with no unsightly hook hanging on top of your graphic.

Complete with carrying bag.

Price - 159.00 ea.



Color	Weight
Silver	10 lbs

Panel Guide	
Panel Size	Visible Height
33 x 83.86 in	33 x 78.74 in



assembled in 30 seconds



includes carrying case



easy to transport

ALUMINUM ROLL-UP BANNER STAND

The **Roll-Up Banner** is a cost effective system for short term signage or promotions. It is designed with a reinforced fitting for the pole to ensure the display stands straight -no tilting or leaning.

The top panel profile clamps the media securely in place without the need for adhesive strips and the pole attaches to the top panel from behind with no unsightly hook hanging on top of the graphic.

The included carrying bag unzips lengthwise for greater ease and has extra padding over its entire length to ensure the display stays looking great.

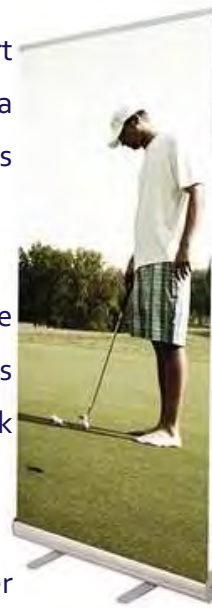

overall size 34"wide x 78" high



A Bargain at 49.90

GIRAFFE BANNER STAND



This Giraffe retractable banner stand is a premium option. The sleek base provides good weight and stability without needing pivoting feet. A protective padded carry bag is included. DI Giraffe banner stand is ideal for long-term use in retail advertising, trade shows, and museums.

This stand holds a 33.7" wide by 78.7" high banner. The top bar holds the banner with clamps. At the bottom, a plastic leader with adhesive tape attaches the banner to the spring-loaded retraction mechanism. Instructions for installing and changing the banner are included with the banner stand. They are printed on the plastic banner leader and should be visible as soon as you open the package. If you are changing the banner, you'll need to pull the banner all the way out to see the plastic banner leader.

Price - 95.00

X BANNER STAND

Size - 23.5" x 63"

Quick Setup - Light Weight - Flexible

Foldable - can be fitted into a carrying bag

Re-usable - Competively priced

Graphics not included - frame only

Price 24.30 ea.



ART SUPPLIES

STABILO PENCIL



Write on all surfaces . . Paper .. Photographics .. Photostats .. Mylar .. Cellophane
 • Porcelain • Vellon • Glass • Film • Plastic.

The best pencil for laying out on glass or plastic signs. Makes a thin line, easily removed.
 Available in: White Blue Black Red Graphite Green Yellow Orange

Each - 2.75 29.95 box of 12

Curved Point Tweezers - 6"



For accurate control in sorting, probing, and precision work. Needle sharp - Light tension.
 Curved point surgical steel. 6 inches

7.70 ea.



Sharp Point Tweezers - 4 3/4"

For accurate control in sorting, probing, and precision work. Needle sharp - Light tension. Surgical Steel.

7.70 ea.



CHALKMARK[™] GF 290

5 Mil Black Chalkboard Vinyl

For use with soft chalks, & fluorescent liquid markers.
 Transforms most smooth surfaces into a removable Chalkboard.
 Printable with white UV curable inks.
 High performance revolvable adhesive with exceptional bond.
 Removes cleanly from most surfaces.
 Compliant with CPSIA 2008, RoHS and REACH

Product No.	Roll Size	Roll Price-25yds.
290-4875	48"x75 ft.	449.00 (17.96 yd)

Summary: GF 290 ChalkMark[™] vinyl is a 5.0 mil matte black embossed chalkboard vinyl with a clear high-tack removable adhesive on a 90# liner. The 5.0 mil ChalkMark vinyl is designed for use with soft chalks and liquid chalk markers, and has a washable surface. The HTR adhesive works great on smooth painted drywall, plastic a-frame signs, metals and glass. ChalkMark[™] is commonly used to produce decorative wall graphics covering large areas for menu boards or murals. GF 290 ChalkMark can also be used to create promotion graphics, plasticade signs, point-of-purchase graphics and craft cut shapes and decals.

S E L E C T I O N G U I D E

DIGITAL PRINT MEDIA

OVERLAMINATES

MOUNTING FILMS



AUTOMARK™ CAST
with DRIFT™ Technology

AutoMark



ROUGH Mark
MODERATELY TEXTURED SURFACE



TRAFFIC GRAFFIC



TransMark



MetroMark



WallMark



MOTO MARK



Window perf



Glass Etch Vinyl

Graphic Commerce Ltd.

1675 Sismet Road, Units 4 & 5, Mississauga, L4W 4K8

phone (905)624-3124 toll free 1-800-543-2796

email - info@graphiccommerce.com

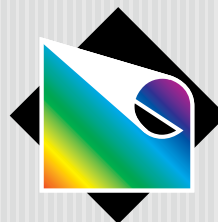

General
FORMULATIONS

The chart below explains the symbol legends shown on each of the films in this catalogue.

It lists the type of adhesive in each film and types of printing methods usable with each film.

See the back cover of this catalogue for the various sign applications recommended for each film product in the catalogue.



ADHESIVE LEGEND

- | | | | |
|--|---|--|--|
| | Permanent Adhesive / Clear | | Removable Repositionable Wall Adhesive / Clear |
| | Permanent Adhesive / Grey | | Removable Adhesive / Clear |
| | Permanent Repositionable Adhesive / Grey | | Low-Tack Removable Adhesive / Clear |
| | Repositionable Removable Adhesive / Clear | | High-Tack Removable Adhesive / Clear |
| | Permanent Opaque Adhesive / Grey | | High-Tack LSE* Permanent Adhesive / Clear |
| | Repositionable Removable Adhesive / Grey | | High-Tack Permanent Adhesive / Clear |
| | Permanent Adhesive / Clear | | High-Tack Permanent Adhesive / Clear |
| | Slidable Repositionable Removable Adhesive / Grey | | High-Tack Removable Adhesive / Clear |
| | | | Removable Adhesive / Clear |



Eco-Solvent, Solvent, Latex & UV Curable Inkjet Printers

MATTE WHITES

MATTE WHITES

SERIES	PRODUCT DESCRIPTION	DURABILITY / REMOVABILITY	PART #	SIZE	ROLL PRICE	per sq. ft.	ADHESIVE / INK TYPE
201	3.4 mil - Matte White Vinyl Clear Permanent Adhesive 90# Layflat Liner	5 yr / -	201-54	54"x150'	349.00	.51	
			201-60	60"x150'	396.00	.53	
201-HTAP	3.4 mil - Matte White Vinyl Clear High-Tack Permanent Adhesive 90# Layflat Liner	5 yr / -	201-HTAP-54	54"x150'	404.00	.59	
			201-HTAP-60	60"x150'	449.00	.68	
201-HTAPAE	3.4 mil - Matte White Vinyl Clear High-Tack Permanent Adhesive 90# Air Egress Layflat Liner	5 yr / -	201-HTAPAE-54	54"x150'	457.00	.68	
201-OAP	3.4 mil - Matte White Opaque Vinyl Grey Permanent Adhesive 90# Layflat Liner	5 yr / -	201-OAP-54	54"x150'	357.00	.53	
			201-OAP-60	60"x150'	399.00	.53	
201OPAE NEW	3.4 mil - Matte White Opaque Vinyl Grey Solvent Permanent Adhesive 90# Air Egress Layflat Liner	5 yr / -	201OPAE-54	54"x150'	453.00	.68	
202	3.4 mil - Matte White Vinyl Clear Low-Tack Removable Adhesive 90# Layflat Liner	5 yr / 1 yr	202-54	54"x150'	369.00	.55	
			202-60	60"x150'	420.00	.56	
214	3.2 mil - Matte White Promotional Vinyl Clear Permanent Adhesive 70# Layflat Liner	3 yr / -	214-54	54"x150'	295.00	.44	
			214-60	60"x150'	326.00	.42	
222	6.0 mil - Matte White Semi-Rigid Vinyl Clear Permanent Adhesive 90# Tight Release Liner	3 yr / -	222-54	54"x100'	333.00	.73	
223	6.0 mil - Matte White Semi-Rigid Vinyl Clear Low-Tack Removable Adhesive 90# Tight Release Liner	3 yr / 1 yr	223-54	54"x100'	339.00	.76	
			223-60	60"x100'	378.00	.77	

GLOSS WHITES

GLOSS WHITES

203	3.0 mil - Gloss White Vinyl Clear Permanent Adhesive 90# Layflat Liner	5 yr / -	203-54	54"x150'	347.00	.52	
			203-60	60"x150'	386.00	.52	
203-OAP	3.0 mil - Gloss White Opaque Vinyl Grey Permanent Adhesive 90# Layflat Liner	5 yr / -	203-OAP-54	54"x150'	358.00	.53	
203OPAE NEW	3.0 mil - Gloss White Opaque Vinyl Grey Solvent Permanent Adhesive 90# Air Egress Layflat Liner	5 yr / -	203OPAE-54	54"x150'	453.00	.68	
204	3.0 mil - Gloss White Vinyl Clear Low-Tack Removable Adhesive 90# Layflat Liner	5 yr / 1 yr	204-54	54"x150'	362.00	.54	
216	3.2 mil - Gloss White Promotional Vinyl Clear Permanent Adhesive 70# Layflat Liner	3 yr / -	216-54	54"x150'	295.00	.44	
			216-60	60"x150'	326.00	.43	
218	WindowMark™ Blockout 8.0 mil - Gloss White Dual-Layer Blockout Vinyl Clear Removable Adhesive 90# Layflat Liner	3 yr / 1 yr	218-54	54"x100'	529.00	1.18	
220	6.0 mil - Gloss White Semi-Rigid Vinyl Clear Permanent Adhesive 90# Tight Release Liner	3 yr / -	220-54	54"x100'	350.00	.78	
			220-60	60"x100'	388.00	.65	
221	6.0 mil - Gloss White Semi-Rigid Vinyl Clear Low-Tack Removable Adhesive 90# Tight Release Liner	3 yr / 1 yr	221-54	54"x100'	350.00	.78	
			221-60	60"x100'	388.00	.65	
203-HTAP NEW	3.0 mil - Gloss White Vinyl Clear High-Tack Permanent Adhesive 90# Layflat Liner	5 yr /	203HTAP-54	54"x150'	404.00	.59	
203-HTAPAE NEW	3.0 mil - Gloss White Vinyl Clear High-Tack Permanent Adhesive 90# Air Egress Layflat Liner	5 yr /	203HTAPAE-54	54"x150'	457.00	.68	
246	2.4 mil - Gloss White Premium Vinyl Grey Solvent Permanent Repositionable Adhesive 90# Layflat Liner	7 yr / 2 yr	246-54	54"x150'	675.00	.94	

NOTE: All durability statements are estimates based on unprinted media and deemed to be reliable; however, this information is given without a guarantee and does not constitute a written warranty. Please refer to the specific product bulletins for further information at www.generalformulations.com. 251124



201 GENERAL DIGITAL VINYL MATTE WHITE PERMANENT ADHESIVE



3.4 MIL MATTE WHITE VINYL Clear Permanent Adhesive 90# Layflat Liner

- For General Signage, Decals, Point-of-Purchase, Exhibit, and Architectural Graphics (interior/exterior)
- Excellent Printability with Solvent, Eco-Solvent, UV Curable and Latex inks
- 5 Year Durability

www.generalformulations.com

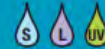

GF12.2020



201 OAP GENERAL DIGITAL VINYL MATTE WHITE GREY PERMANENT ADHESIVE



3.4 MIL MATTE WHITE OPAQUE VINYL Grey Permanent Adhesive 90# Layflat Liner

- For General Signage, Decals, Point-of-Purchase, Exhibit, and Architectural Graphics (interior/exterior)
- Grey Adhesive for Added Opacity
- Excellent Printability with Solvent, Eco-Solvent, UV Curable and Latex inks
- 5 Year Durability

www.generalformulations.com



Digital Print Media for Eco-Solvent, Solvent, Latex & UV Curable Inkjet Printers

GLOSS CLEARS

GLOSS CLEARS

SERIES	PRODUCT DESCRIPTION	DURABILITY / REMOVABILITY	PART #	SIZE	ROLL PRICE	per sq. ft.	ADHESIVE / INK TYPE
205	3.0 mil - Gloss Clear Vinyl Clear Permanent Adhesive 90# Layflat Liner	3 yr / 1 yr	205-54	54"x150'	375.00	.55	
			205-60	60"x150'	426.00	.56	
206	3.0 mil - Gloss Clear Vinyl Clear Low-Tack Removable Adhesive 90# Layflat Liner	3 yr / 1 yr	206-54	54"x150'	383.00	.56	
			206-60	60"x150'	431.00	.57	
219	6.0 mil - Gloss Clear Semi-Rigid Vinyl Clear Low-Tack Removable Adhesive 90# Tight Release Liner	3 yr / 1 yr	219-54	54"x100'	349.00	.77	
255	3.0 mil - Optically Clear Gloss Vinyl Optically Clear Solvent Removable Adhesive 2.0 mil Traction Backed Polyester Liner	3 yr / 1 yr	255-54	54"x150'	591.00	1.02	
247	New Face Film Print-n-Lam 3.0 mil - Clear Gloss UV Polymeric Vinyl - 7 yr Clear Permanent Adhesive 90# Layflat Liner		247-54	54"x150'	458.00	.68	

MATTE CLEAR

MATTE CLEARS

248	New Face Film Print-n-Lam 3.0 mil - Matte Clear UV Polymeric Vinyl - 7 yr Clear Permanent Adhesive 90# Layflat Liner		248-54	54"x150'	458.00	.68	
287	ROUGHMark RoughMark Clear 3.5 mil - Matte Clear Polymeric Conformable Wall Vinyl Clear Solvent High-Tack Removable Adhesive 90# Layflat Liner <i>(If Laminate is desired, Concept 242 Gloss Laminate is recommended)</i>	5 yr / 6 mo	287-5475	54"x75'	473.00	1.40	
			287-54	54"x150'	895.00	1.33	

TRANSIT

TRANSIT FILMS

209	MetroMark 3.5 mil - Matte White Opaque Transit Vinyl 5 yr / 1 yr Clear Removable Adhesive 90# Layflat Printed Logo Liner		209-54	54"x150'	416.00	.60	
209AE	OUTFRONT media / Approved 209AE-w/Air Engress liner		209-60	64"x150'	490.00	.60	
275	SubMark 3.5 mil - Matte White Opaque Transit Vinyl 5 yr / - Clear High-Tack Adhesive 90# Layflat Printed Logo Liner OUTFRONT media / TITAN Approved		275-54	54"x150'	693.00	1.03	
228	TransMark 6.0 mil - Matte White Translucent Vinyl 3 yr / 1 yr Clear Solvent Removable Adhesive 90# Layflat Liner VERIFONEMEDIA Taxi Top Approved		228-54	54"x100'	733.00	1.63	
232	WindowMark 6.0 mil - Matte White Perforated 50/50 Film White Face/Black Back - Clear Removable Adhesive 84# Layflat with Dual Liner Technology <i>(242 Laminate Recommended)</i> OUTFRONT media Approved	2 yr / 1 yr	232-54	54"x100'	1053.00	2.34	
			Part Roll Price - 54" Wide 1-9 yds. -42.10 yd. 10-33 yds.-36.75yd.				
277	MetroGrafix / WindowMark 4.0 mil - Matte White Opaque Vinyl - 5 yr Clear Removable Solvent Adhesive 90# Layflat "MetroGrafix Logo" Liner For Bus and Train Applications.(Body Tall) Combines with GF101 Lustre Laminate		277-54	54"x150'	674.00	.99	

TRANSLUCENTS

TRANSLUCENTS

224	TransMark 3.2 mil - Matte White Translucent Vinyl 5 yr / - Clear Solvent Permanent Adhesive 90# Layflat Liner		224-54	54"x150'	889.00	1.31	
228	TransMark 6.0 mil - Matte White Translucent Vinyl Clear Solvent Removable Adhesive 90# Layflat Liner VERIFONEMEDIA Taxi Top Approved	3 yr / 1 yr	228-54	54"x100'	733.00	1.63	



201 HTAP HIGH-TACK VINYL MATTE WHITE PERMANENT ADHESIVE



3.4 MIL MATTE WHITE CALENDERED VINYL Clear High-Tack Permanent Adhesive 90# Layflat Liner

- For Interior or Exterior Signage, Point-of-Purchase Displays, Product I.D. Labels, Nameplates and Decals
- Superior Bond to MDO Board, Powder Coated Metals, ABS, Sintra Board, Coroplast, HDPE, Styrene, Polypropylene and Polyolefin
- Excellent Printability with Solvent, Eco-Solvent, UV Curable and Latex inks
- 5 Year Durability

www.generalformulations.com



287 WALL VINYL MATTE CLEAR REMOVABLE ADHESIVE



3.0 MIL MATTE CLEAR CONFORMABLE WALL VINYL Clear High-Tack Removable Adhesive 90# Layflat Liner

- Thick HTR adhesive aggressively bonds yet provides clean removability for 6 months from most surfaces
- Matte Clear film provides a painted-on look
- Designed for moderately textured surfaces, this high opacity film conforms with heat to Brick, Cement, & Cinder Block Walls
- Safe for all spaces with its E84 Class A Fire rating and compliance with REACH, RoHS and Prop 65

www.generalformulations.com





















ROUGHMARK™ CLEAR

Digital Print Media for Eco-Solvent, Solvent, Latex & UV Curable Inkjet Printers

FLOOR & CARPET (indoor only)



























FLOOR & CARPET (indoor only)

SERIES	PRODUCT DESCRIPTION	DURABILITY / REMOVABILITY	PART #	SIZE	ROLL PRICE	per sq. ft.	ADHESIVE / INK TYPE
**210	 Traffic Graffiti 3.4 mil - Matte White "Floor Advertising" Vinyl Clear Removable Adhesive 90# Layflat Liner	5 yr / 6 mo	210-54	54"x150'	427.00	.64	   
			210-60	60"x150'	485.00	.64	
**212	 Traffic Graffiti 3.4 mil - Matte White "Carpet Advertising" Vinyl Clear High-Tack Removable Adhesive 90# Layflat Liner	5 yr / 6 mo	212-54	54"x150'	450.00	.66	   
*211	 Traffic Graffiti 6.0 mil - Gloss Clear Laminate Clear Permanent Adhesive 53# Liner	- / -	211-54	54"x150'	617.00	.92	
			1 to 9 yds. - 15.45 yd. 10 yds. - 140.00				
*109	 Traffic Graffiti 5.0 mil - Scratch Resistant Textured PVC Laminate Clear Permanent Adhesive 1.5 mil Clear Polyester Liner	- / -	109-38	38"x150'	611.00	1.29	
				1 to 9 yds. - 15.30 yd. 10 yds. - 140.00			
			109-54	54"x150'	611.00	1.29	
			1 to 9 yds. - 16.95 yd. 10 yds. - 155.50				
*213	 Traffic Graffiti 3.75 mil - Embossed Clear Polypropylene Laminate Clear Permanent Adhesive 53# Liner <i>Indirect Food Contact Solution - The film and adhesive complies with the following citations in 21CFR 174 thru 182 and 21CFR 175.105 respectively</i>	- / -	213-54	54"x150'	426.00	.64	
*217	 Traffic Graffiti 3.0 mil - Gloss Clear PVC Laminate Clear Permanent Adhesive 53# Liner	- / -	217-54	54"x150'	422.00	.63	

 **TRAFFIC GRAFFIC CLASSIFIED BY UNDERWRITERS LABORATORIES, INC.® AS TO SLIP RESISTANCE ONLY UL410**
****DURABILITY AND REMOVABILITY SPECIFICATIONS ARE CONTINGENT UPON USING TRAFFIC GRAFFIC MATCHED COMPONENT SYSTEM (CONCEPT BASE MEDIA & CONCEPT UL RATED LAMINATE)**

WALLS (indoor only)











WALLS (indoor only)

226 & 226HTR	 WallMark 6.0 mil - Matte White Semi-Rigid Wall Vinyl Clear Low-Tack Microsphere Beaded Adhesive 90# Tight Release Liner 226 HTR has High Tack Removable Adhesive	5yr / 1 yr	226-54	54"x100'	453.00	1.01	   
			226-54HTR	54"x100'	484.00	1.08	
229 & 229HTR	 WallMark Canvas 6.0 mil - Matte White Embossed Canvas Wall Vinyl Clear Low-Tack Microsphere Beaded Adhesive 90# Tight Release Liner (ASTM E84 Class 1) 229HTR has High tack Removable Adhesive	5yr / 1 yr	229-54	54"x100'	564.00	1.26	   
			229-54HTR	54"x100'	652.00	1.46	
234	 GraphiTex 7.0 mil - Matte White Polyester Wall Fabric Clear Low-Tack Wall Adhesive 90# Layflat Liner	5 yr / 1 yr	234-54	54"x100'	774.00	1.72	   
253	 GraphiTex Opaque (99% opaque) 6.0 mil - Matte White Opaque Polyester Wall Fabric Clear Re-Positionable Wall Adhesive 90# Layflat Liner. Clean removable from most surfaces for 1 yr.	10yr / 1 yr	253-54	54"x100'	845.00	1.88	   
290 NEW	 ChalkMark 5 mil - Black Chalkboard Vinyl Clear Solvent High-Tack Removable Adhesive 90# Layflat Liner * UV curable ink only	5 yr / 1 yr	290-4875	48"x75'	449.00	1.51	 
250	 WallFrog 4.0 mil - Matte White Polyester Wall Fabric Clear Low-Tack Wall Adhesive 90# Layflat Liner	5 yr / 1 yr	250-54	54"x100'	589.00	1.31	   

Part Roll Price - 54" Wide only 1-9 yds. -21.20 yd. 10-33 yds.-19.30 yd.

WALLS

(indoor/outdoor)

285 NEW	 RoughMark 3.5 mil - Matte White Polymeric Conformable Wall Vinyl Clear Solvent High-Tack Removable Adhesive 90# Layflat Liner (If Laminate is desired, Concept 242 Gloss Laminate is recommended)	5 yr / 6 mo	285-5475	54"x 75'	438.00	1.30	   
			285-54	54"x150'	829.00	1.23	
287 NEW	 RoughMark Clear 3.5 mil - Matte Clear Polymeric Conformable Wall Vinyl Clear Solvent High-Tack Removable Adhesive 90# Layflat Liner (If Laminate is desired, Concept 242 Gloss Laminate is recommended)	5 yr / 6 mo	287-5475	54"x75'	438.00	1.30	   
			287-54	54"x150'	829.00	1.23	



**STEP INTO
MORE
PROFITS**

**SCUFF & SCRATCH
APPROVED
RESISTANT**

5 MIL SCRATCH RESISTANT TEXTURED PVC LAMINATE

- Meets UL Slip Resistance Standards
- Clear Solvent Adhesive for Excellent Clarity
- Thick Construction Allows for Easy Installation
- Printed on GF 210 Floor Media and Laminated with GF 109

GF 109 IS CLASSIFIED BY UNDERWRITERS LABORATORIES, INC.™ AS TO SLIP RESISTANCE ONLY ACCORDING TO UL 410

Description:

GF 109 is a 5.0 mil scratch resistant clear laminate with a textured matte finish. This laminating film is an inexpensive and durable alternative to polycarbonate film. It has a permanent acrylic pressure sensitive adhesive formulated for exceptional clarity. Produced on a 1.5 mil polyester clear liner, the laminate has an extremely smooth adhesive coating. GF 109 can be paired with approved print films to create graphics for tile and carpet. GF 109 has been rated for slip resistance based on multiple testing methods.

GF 242 Gloss Optically Clear Vinyl Laminate Film



Description:

GF 242 Optically Clear Cast Overlaminating Film is a pressure sensitive vinyl with an optically clear permanent solvent pressure sensitive adhesive on a smooth frosted polyester liner. This glossy flexible vinyl affords protection to graphics from ultra violet radiation, moisture and abrasion. GF 242 is recommended as an overlay on GF 232, GF 260, GF 261, GF 270, and GF 280 perforated window films. GF 242 also works well for many other applications where a high-gloss finish is required. Cold laminating techniques are recommended when applying this film.

Digital Print Media for Eco-Solvent, Solvent, Latex & UV Curable Inkjet Printers

WINDOWS

SERIES	PRODUCT DESCRIPTION	DURABILITY / REMOVABILITY	PART #	SIZE	ROLL PRICE	per sq. ft.	ADHESIVE / INK TYPE
202	3.4 mil - Matte White Vinyl Clear Low-Tack Removable Adhesive 90# Layflat Liner	5 yr / 1 yr	202-54	54"x150'	369.00	.55	
			202-60	60"x150'	420.00	.56	
204	3.0 mil - Gloss White Vinyl Clear Low-Tack Removable Adhesive 90# Layflat Liner	5 yr / 1 yr	204-54	54"x150'	362.00	.54	
206	3.0 mil - Gloss Clear Vinyl Clear Low-Tack Removable Adhesive 90# Layflat Liner	3 yr / 1 yr	206-54	54"x150'	383.00	.54	
			206-60	60"x150'	431.00	.57	
218	WindowMark™ Blockout 8.0 mil - Gloss White Dual-Layer Blockout Vinyl Clear Removable Adhesive 90# Layflat Liner	3 yr / 1 yr	218-54	54"x100'	529.00	1.18	
219	6.0 mil - Gloss Clear Semi-Rigid Vinyl Clear Low-Tack Removable Adhesive 90# Tight Release Liner	3 yr / 1 yr	219-54	54"x100'	349.00	.78	
221	6.0 mil - Gloss White Semi-Rigid Vinyl Clear Low-Tack Removable Adhesive 90# Tight Release Liner	3 yr / 1 yr	221-54	54"x100'	350.00	.81	
			221-60	60"x100'	388.00	.65	
223	6.0 mil - Matte White Semi-Rigid Vinyl Clear Low-Tack Removable Adhesive 90# Tight Release Liner	3 yr / 1 yr	223-54	54"x100'	339.00	.76	
			223-60	60"x100'	378.00	.63	
255	3.0 mil - Optically Clear Gloss Vinyl Optically Clear Solvent Removable Adhesive 2.0 mil Traction Backed Polyester Liner	3 yr / 1 yr	255-54	54"x150'	591.00	.87	
228	TransMark 6.0 mil - Matte White Translucent Vinyl Clear Removable Adhesive 90# Layflat Liner VERIFONEMEDIA Taxi Top Approved	3 yr / 1 yr	228-54	54"x100'	733.00	1.63	

229 HTR WALL VINYL MATTE WHITE REMOVABLE ADHESIVE



Embossed Canvas Wall

262 HTR WALL VINYL MATTE WHITE REMOVABLE ADHESIVE



Sand Embossed Wall

263 HTR WALL VINYL MATTE WHITE REMOVABLE ADHESIVE



Stucco Embossed Wall

264 HTR WALL VINYL MATTE WHITE REMOVABLE ADHESIVE



Leather Embossed Wall

229HTR+ NEW	WallMark® Canvas HTR 6.0 mil - Matte White Embossed Canvas Wall Vinyl Clear Solvent High-Tack Removable Adhesive 90# Layflat Liner	5 yr* / 1 yr	229HTR	54"x100'	652.00	1.34 sq.ft.	
262HTR+ NEW	WallMark® Sand HTR 6.0 mil - Matte White Sand Embossed Wall Vinyl Clear Solvent High-Tack Removable Adhesive 90# Layflat Liner	5 yr* / 1 yr	262HTR	54"x100'	652.00	1.34 sq.ft.	
263HTR+ NEW	WallMark® Stucco HTR 6.0 mil - Matte White Stucco Embossed Wall Vinyl Clear Solvent High-Tack Removable Adhesive 90# Layflat Liner	5 yr* / 1 yr	263HTR	54"x100'	652.00	1.34 sq.ft.	
264HTR+ NEW	WallMark® Leather HTR 6.0 mil - Matte White Leather Embossed Wall Vinyl Clear Solvent High-Tack Removable Adhesive 90# Layflat Liner	5 yr* / 1 yr	264HTR	54"x100'	652.00	1.34 sq.ft.	

GF ECONOMY PRINT & LAMINATE SERIES - FOR SHORTER TERM GRAPHICS

GF 160



GF-160 Economy Series 3.0 mil gloss Clear Vinyl Laminate, perm. adhesive, 75# 2-Side Poly-Coated Liner

\$279.00

GF 162



GF-162 Economy Series 3.0 mil matte Clear Vinyl Laminate, perm. adhesive, 75# 2-Side Poly-Coated Liner

\$279.00

GF 364



GF-364 Economy Series 3.0 mil matte white vinyl, clear perm. adhesive, 75# 2-Side Poly-Coated Liner

\$279.00

GF 364OP



GF-364OP - Economy Series - 3.0 mil Matte White Vinyl, grey perm. adhesive, 75# 2-Side Poly-Coated Liner

\$313.00

GF 364OPAE



364-OPAE - Economy Series 3.0 mil matte white vinyl, grey perm. adhesive, 75# Air Egress 2 Side Poly-Coated Liner

\$352.00

GF 365



GF-365 Economy Series 3.0 mil gloss white vinyl, clear perm. adhesive, 75# 2-Side Poly-Coated Liner

\$279.00

GF 365OP



GF-365OP - Economy Series - 3.0 mil gloss white vinyl grey perm. adhesive, 75# 2 Side poly coated liner
\$313.00

GF 365OPAE



GF-365OPAE - Economy Series - 3.0 mil gloss white vinyl grey perm. adhesive, 75# Air Egress 2 Side poly-coated liner
\$352.00

TRAFFIC GRAFFIC FLOOR FILMS



Eli and Edythe Broad Art Museum / Michigan State University / **Concept** © 210 & 211 Traffic Graffix Media
Photo courtesy of Aaron Word / Printing by Engineering Graphics, Inc. / Installation by Sanborn Signcrafters

WRAP MEDIA





PHOTO: Wrap Nation, Phoenix AZ

MEDIA: AutoMark™ **Concept**© 230 film & 231 laminate

Digital Print Media for Eco-Solvent, Solvent, Latex & UV Curable Inkjet Printers

SERIES	PRODUCT DESCRIPTION	DURABILITY / REMOVABILITY	PART #	SIZE	ROLL PRICE	per sq. ft.	ADHESIVE / INK TYPE
207	7.0 mil - Clear Static Cling 90# Layflat Liner	3 mo / -	207-54	54"x75'	206.00	.62	S L UV
208	7.0 mil - White Static Cling 90# Layflat Liner		208-54	54"x75'	212.00	.63	

790AE NEW PRINT-n-PRIVACY	Print-n-Privacy 3.0 mil - Polymeric Glass Etch Film (Light) Clear Solvent Permanent Adhesive 90# Paper Air Egress Liner (Dry Apply Only)	7 yr / -	790AE-60	54"x75'	616.00	1.83	 
			790AE-54	54"x150'	1089.00	1.62	

Printable w/Solvent, Latex or UV

WRAP FILMS



WRAP FILMS

230 	AutoMark 2.4 mil - Gloss White Conformable Wrap Vinyl Grey Solvent Permanent Repositionable Adhesive 90# Air Egress Layflat Liner	7 yr / 2 yr	230-54	54"x150'	798.00	1.18	 
			230-60	60"x150'	888.00	1.18	
			Part Roll Price - 54" Wide				
			1-9 yds. - 20.10 yd.		10 yds. - 183.50 yd.		
231 	AutoMark 2.4 mil - Gloss Clear UV Wrap Laminate Clear Solvent Permanent Adhesive 53# Liner	5 yr / -	231-54	54"x150'	514.00	.76	
			Part Roll Price - 54" Wide				
			1-9 yds. - 12.95 yd.		10 yds. - 122.00 yd.		
240 	AutoMark 2.4 mil - Matte Clear UV Wrap Laminate Clear Solvent Permanent Adhesive 53# Liner	5 yr / -	240-54	54"x150'	514.00	.76	
			Part Roll Price - 54" Wide				
			1-9 yds. - 12.95 yd.		10 yds. - 122.00 yd.		
333 NEW 	AutoMark 3.0 mil - Gloss White Polymeric Vinyl - 7 yr. Clear Slideable Repositionable Solvent Adhesive 105# Air Agress Liner	7 yr / -	333-54	54"x150'	637.00	.89	 
			AutoMark Drift PW				

PERF FILM

General Formulations



232 	WindowMark 6.0 mil - Matte White Perforated 50/50 Film White Face/Black Back - Clear Removable Adhesive 84# Layflat with Dual Liner Technology (242 Laminate Recommended)	2 yr / 1 yr	232-54	54"x100' (33.3yds.)	975.00	
			Part Roll Price - 54" Wide			
			1-9 yds. - 39.00 yd.		10 yds. - 340.00	

PERF FILM



AUTOMARK™ CAST

with DRIFT® Technology



GF 830 AutoMark™ Cast with DRIFT® Technology is a premium full-body gloss white cast wrap film. The DRIFT® Technology and adhesive combination is engineered to provide superior repositionability and slidability. Developed to meet the long-term demands of full or partial fleet and vehicle wraps as well as many other graphic applications. DRIFT® Technology offers the right amount of adhesive tack with Micro Air Egress channels that allow for quick, easy and bubble-free applications. GF 830 AutoMark™ Cast provides an excellent white point, delivering the perfect solution for high-quality printing across Eco-Solvent, Solvent, Latex, and UV print systems.

Unique Features:

- Full-Body Cast Film with Superior Repositionability
- Excellent White Point for Vibrant Printing
- DRIFT® Technology provides
- Bubble-Free Applications



Watch this video to learn more

[CLICK HERE](#)

Adhesive & Liner:



Ink Compatibility:



Applications:

- Vehicle Graphics
- Fleet Graphics

Overlaminates:

- GF 242 OptiMark™ Gloss Optically Clear UV Cast Laminate
- GF 813 AutoMark™ High Gloss Clear UV Cast Laminate
- GF 831 AutoMark™ Gloss Clear UV Cast

Product	Description	NO.	SIZE	PRICE	SF-\$
830 AutoMark™ Cast w/DRIFT® Technology	2.0 mil - Gloss White Cast Wrap - 8 yr Grey Solvent Slidable, Repositionable, Long Term Removable Adhesive 106# Air Egress (AE) Layflat Liner	830-54	54"x150'	\$1328.00	\$1.99
		830-60	60"x150'	\$1476.00	\$1.97
813 NEW AutoMark™ Cast Laminate	1.3 mil - Gloss Clear Cast Laminate - 8 yr 74# Liner Clear Solvent Permanent Adhesive	813-54	54"x150'	\$936.00	\$1.39
		813-60	60"x150'	\$1010.00	\$1.34
831 AutoMark™ Cast Laminate	2.0 mil - Gloss Clear UV Cast Laminate - 8 yr 74# Liner Clear Solvent Permanent Adhesive	831-54	54"x150'	\$1007.00	\$1.49
		831-60	60"x150'	\$1086.00	\$1.46
840 AutoMark™ Cast Laminate	2.0 mil - Matte Clear UV Cast Laminate - 8 yr 74# Liner Clear Solvent Permanent Adhesive	840-54	54"x150'	\$1007.00	\$1.49
		840-60	60"x150'	\$1086.00	\$1.46
844 NEW AutoMark™ Cast Laminate	2.0 mil - Ulti- Matte Clear Cast Laminate - 8 yr 74# Liner Clear Solvent Permanent Adhesive	844-54	54"x150'	\$1007.00	\$1.49
		844-60	60"x150'	\$1086.00	\$1.46

Digital Print Media for Eco-Solvent, Solvent, Latex & UV Curable Inkjet Printers

SERIES	PRODUCT DESCRIPTION	DURABILITY / REMOVABILITY	PART #	SIZE	ROLL PRICE	per sq. ft.	ADHESIVE / INK TYPE
--------	---------------------	---------------------------	--------	------	------------	-------------	---------------------

*LSE SPECIALTY

*LSE SPECIALTY

235



MotoMark - Grip
Matte White 4 mil Vinyl
 Clear Solvent High Bond *LSE Permanent Adhesive
 90# Layflat Liner

5 yr / -

235-24	24x150'	665.00	2.23
235-54	54x150'	1449.00	2.14

*LOW SURFACE ENERGY



238



MotoMark - Armor
Gloss Clear 12 mil UV Laminate
 Clear Solvent Permanent Adhesive
 53# Liner

5 yr / -

238-24	24"x75"	366.00	2.43
238-54	54"x75"	689.00	2.07



STATIC CLINGS

STATIC CLINGS

*207

7.0 mil - Clear Static Cling
 90# Layflat Liner

3 mo / -

207-54	54"x75"	206.00	.62
--------	---------	--------	-----



*208

7.0 mil - White Static Cling
 90# Layflat Liner

3 mo / -

208-54	54"x75"	212.00	.63
--------	---------	--------	-----



*NOT INTENDED FOR INSIDE MOUNT APPLICATIONS. PLEASE SEE PRODUCT BULLETIN AT WWW.GENERALFORMULATIONS.COM FOR SPECIFIC INSTALLATION INSTRUCTIONS.

OPTICALLY CLEARS

OPTICALLY CLEARS

105

2.0 mil - High Gloss Clear Polyester Laminate
 Optically Clear Permanent Adhesive
 1.5 mil Clear Polyester Liner

2 yr / -

105-54	54"x150'	553.00	.82
--------	----------	--------	-----



106

1.0 mil - Transparent Optically Clear Mount Film
 Optically Clear Solvent Permanent Adhesive - Both Sides
 1.5 mil Clear Polyester Liner - Both Sides
**Indoor only*

1 yr / -

106-54	54"x150'	969.00	1.44
--------	----------	--------	------



242

2.0 mil - Optically Clear UV Gloss Cast Laminate
 Optically Clear Solvent Permanent Adhesive
 2.0 mil Smooth Frosted Polyester Liner
OUTFRONT media Approved

5 yr / -

242-54	54"x150'	1113.00	1.66
Part Roll Price - 54" Wide			
1-9 yds. -27.75 yd.		10-33 yds.-252.00 yd.	



255

3.0 mil - Optically Clear Gloss Vinyl
 Optically Clear Solvent Removable Adhesive
 2.0 mil Traction Backed Polyester Liner

3 yr / 1 yr

255-54	54"x150'	591.00	.88
--------	----------	--------	-----



TEDLAR®

TEDLAR

108 NEW

Tedlar® by Dupont™
1.0 mil - Clear Tedlar® Overlaminate
 Clear Solvent Permanent Adhesive
 53# Liner

10 yr / -

108-54	54"x150'	1204.00	1.79
--------	----------	---------	------



Part Roll 1 to 9 yds. - 31.30 per yd. 10 yds. - 292.00

WALL MEDIA - ROUGHMARK

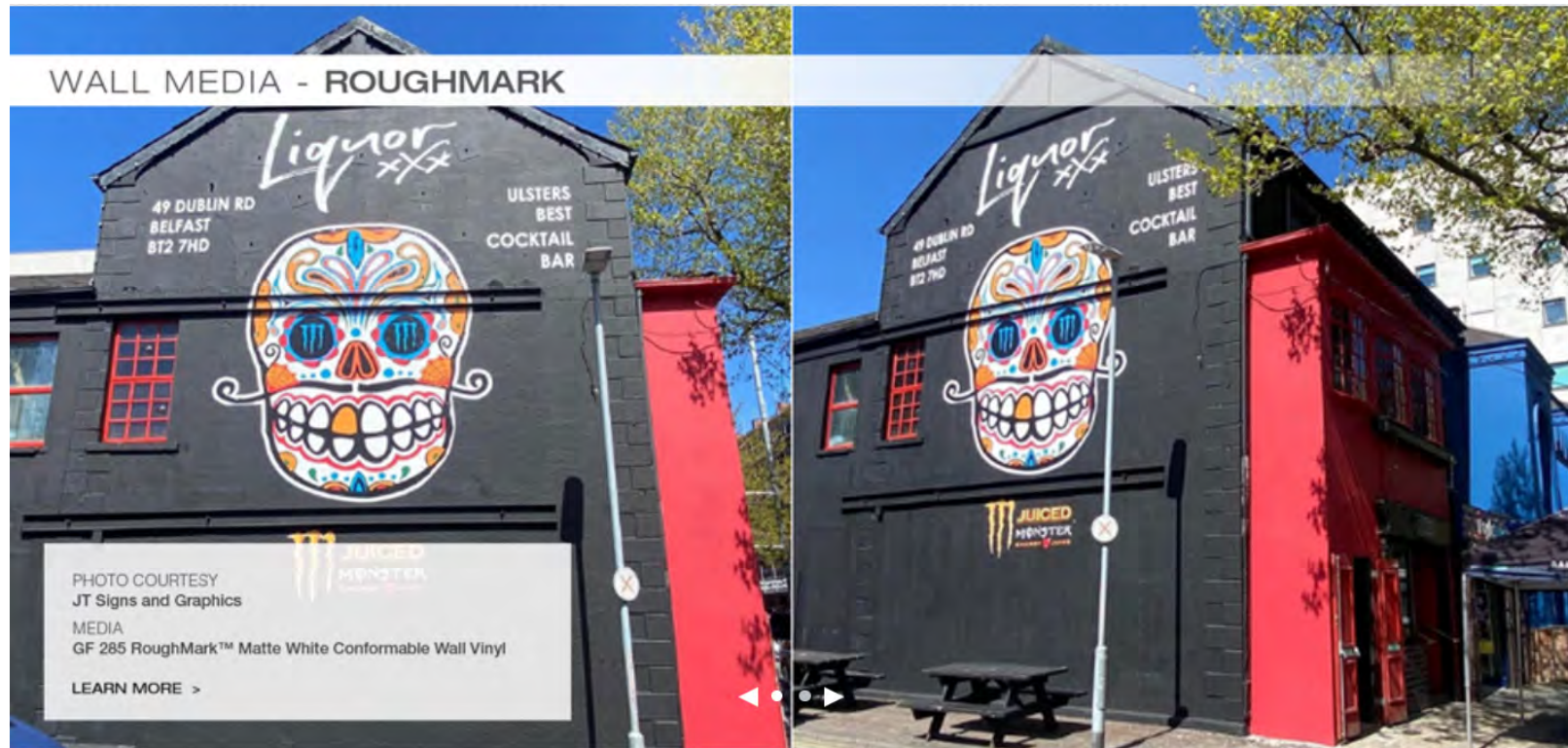









STATIC CLING

207 Clear or 208 White





Laminating Films

GENERAL USE & UV LAMINATES

SERIES	PRODUCT DESCRIPTION	DURABILITY / REMOVABILITY	PART #	SIZE	ROLL PRICE	per sq. ft.	ADHESIVE / INK TYPE
		1 yr / -					
100	3.0 mil - Gloss Clear PVC Laminate Clear Permanent Adhesive 53# Liner		100-51 100-54 100-60	51"x150' 54"x150' 60"x150'	351.00 370.00 415.00	.55 .55 .55	
101	3.0 mil - Lustre Clear PVC Laminate 1 yr / - Clear Permanent Adhesive 53# Liner VERIFONEMEDIA Taxi Top Solution Product OUTFRONT / TITAN Approved		101-51 101-54 101-60	51"x150' 54"x150' 60"x150'	351.00 370.00 415.00	.55 .55 .55	
102	3.0 mil - Matte Clear PVC Laminate 1 yr / - Clear Permanent Adhesive 53# Liner		102-51 102-54 102-60	51"x150' 54"x150' 60"x150'	351.00 370.00 415.00	.55 .55 .55	
400	3.0 mil - Gloss UV Clear PVC Laminate 4 yr / - Clear Permanent Adhesive 53# Liner		400-54	54"x150'	422.00	.63	
401	3.0 mil - Lustre UV Clear PVC Laminate 4 yr / - Clear Permanent Adhesive 53# Liner		401-54	54"x150'	422.00	.63	
402	3.0 mil - Matte UV Clear PVC Laminate 4 yr / - Clear Permanent Adhesive 53# Liner		402-54	54"x150'	422.00	.63	
231	AutoMark 2.4 mil - Gloss Clear UV Wrap Laminate Clear Solvent Permanent Adhesive 53# Liner	5 yr / -	231-5	54"x150'	514.00	.76	
			Part Roll Price - 54" Wide				
			1-9 yds. - 12.95 yd.		10-49 yds.-122.00		
240	AutoMark 2.4 mil - Matte Clear UV Wrap Laminate Clear Solvent Permanent Adhesive 53# Liner	5 yr / -	240-54	54"x150'	514.00	.76	
238	MotoMark - Armor Gloss Clear 12 mil "ARMOR" UV Laminate Clear Solvent Permanent Adhesive 53# Liner	5 yr / -	238-24 238-54	24"x75' 54"x75'	366.00 689.00	2.44 2.06	

DRY ERASE (indoor only)

110 NEW	EraseMark Pro™ 2.0 mil - Commercial Grade Dry Erase Gloss Clear Polyester Laminate High Performance Engineered Surface Clear Permanent Adhesive 53# Liner	5 yr / -	110-54	54"x150'	777.00	1.15	
					Rolls Only		
111	EraseMark™ 2.0 mil - Dry Erase Gloss Clear Laminate Polypropylene Clear Permanent Adhesive 53# Liner <i>*Please review product data bulletin for recommended applications. Intended for short term / indoor use only (3-6 months, not a commercial use product)</i>	- / -	111-54	54"x150'	366.00	.54	
			Part Rolls		1-9 yds. -10.35 yd. 10 yds. -92.00 roll 50 yds. -366.00		

DRY ERASE (indoor only)



3 MIL OPTICALLY CLEAR REMOVABLE VINYL

- Optically Clear Vinyl on a 2 mil PET Liner
- Removable up to one year
- Compatible with Solvent, UV, and Latex inks
- Can be wet applied
- For temporary or short term graphics

333 WRAP VINYL GLOSS WHITE SLIDABLE ADHESIVE



3 MIL GLOSS WHITE POLYMERIC WRAP VINYL

Grey Solvent Slidable Repositionable Adhesive
105# Air Egress Layflat Liner - 2 yr Clean Removability

- "DRIFT" Technology allows the media to Float or Drift over the surface for easy tack & positioning
- Ideal for Partial-Wrap applications including Vans, Box Trucks, Fleet, Delivery Trucks, and General Signage (not intended for rivets)
- Application Information:
 - 2 yr Clean Removability
 - For flat to simple curves only
 - Up to 7 years durability (unprinted)
- Recommended Laminates:
 - For Partial Wraps: GF 231, GF 240 & GF 242
 - For Flat or General Signage: GF 247 & GF 248

www.generalformulations.com



Laminating & Mounting Films

FLOOR / DISPLAY / COUNTER MATS (indoor only)

FLOOR, DISPLAY, COUNTER MATS - INDOOR

SERIES	PRODUCT DESCRIPTION	DURABILITY / REMOVABILITY	PART #	SIZE	ROLL PRICE	per sq. ft.	ADHESIVE / INK TYPE
103	5.0 mil - Fine Textured Matte Polycarbonate Laminate Clear Permanent Adhesive 1.5 mil Clear Polyester Liner		103-54	54"x150'	1026.00	1.53	
*109	 Traffic Graffiti 5.0 mil - Scratch Resistant Textured PVC Laminate Clear Permanent Adhesive 1.5 mil Clear Polyester Liner	- / -	109-38	38"x150'	611.00	1.29	
				1 to 9 yds. 15.30	10yds. - 140.00		
*109			109-54	54"x150'	678.00	1.01	
				1 to 9 yds. 16.95	10yds. - 155.50		
*211	 Traffic Graffiti 6.0 mil - Gloss Clear Light Emboss Clear Permanent Adhesive 53# Liner	- / -	211-54	54"x150'	571.00	.85	
				1 to 9 yds. 15.45	10yds. - 140.50		
*213 NEW	 Traffic Graffiti 3.75 mil - Embossed Clear Polypropylene Laminate Clear Permanent Adhesive 53# Liner <i>Indirect Food Contact Solution</i> - The film and adhesive complies with the following citations in 21CFR 174 thru 182 and 21CFR 175.105 respectively	- / -	213-54	54"x150'	426.00	.64	
*217 NEW	 Traffic Graffiti 3.0 mil - Gloss Clear PVC Laminate Clear Permanent Adhesive 53# Liner	- / -	217-54	54"x150'	422.00	.63	

* CLASSIFIED UL TRAFFIC GRAFFITI CLASSIFIED BY UNDERWRITERS LABORATORIES, INC.® AS TO SLIP RESISTANCE ONLY UL410

SPECIALTY MOUNTING FILMS

SPECIALTY MOUNTING FILMS

106	1.0 mil - Transparent Polyester Optically Clear Mount Film Optically Clear Solvent Permanent Adhesive - Both Sides 1.5 mil Clear Polyester Liner - Both Sides (Indoor only)	1 yr / -	106-54	54"x150'	969.00	1.43	
107	1.5 mil - White Opaque Print Mount Film White Opaque Polypropylene High-Tack Clear Permanent Adhesive - Both Sides 76# Liner (Self-Wound) (Indoor only)	1 yr / -	107-54	54"x150'	531.00	.78	
112	0.5 mil - Clear Polyester Print Mount Film High-Tack Clear Permanent Adhesive - Both Sides 76# Liner (Self-Wound) (Indoor only)	1 yr / -	112-54	54"x150'	572.00	.85	
113	1.0 mil - Clear Polyester Removable Print Mount Film High-Tack Clear Permanent Adhesive 1-Side Low-Tack Clear Removable Adhesive 1-Side Clear 1.2 mil Polyester Liner Printed* (Self-Wound)	6 mo / 6 mo	113-54	54"x150'	607.00	.90	
114	1.0 mil - Clear Polyester Removable Print Mount Film High-Tack Clear Permanent Adhesive 1-Side Low-Tack Clear Removable Adhesive 1-Side 76# Liner (Self-Wound)	6 mo / 6 mo	114-54	54"x150'	609.00	.91	
116*	1.0 mil - Clear Polyester Removable "Air-Egress" Print Mount Film High-Tack Clear Permanent Adhesive 1-Side / 1 mil PET Clear Liner High-Tack Clear Removable Adhesive 1-Side / 4.5 mil Clear Air Egress Printed* PET Liner	1 yr / 6 mo	116-54	54"x150'	919.00	1.36	
118*	1.0 mil - Clear Polyester Removable Print Mount Film High-Tack Clear Permanent Adhesive 1-Side / 1.5 mil PET Clear Liner Low-Tack Clear Removable Adhesive 1-Side / 1.2 mil Printed* PET Clear Liner	6 mo / 6 mo	118-54	54"x150'	657.00	.98	

*Printed with "Remove to Expose Adhesive" on Adhesive Side

Wrap Bundle Special

AutoMark™ Concept® 230 **WHITE GLOSS WRAP VINYL FILM**

Concept⁰ 230 is a Premium 2.4-mil Calendered gloss white vinyl digital media with a grey permanent acrylic adhesive on an air-egress liner.

This film is designed to accept a variety of solvent-based inkjet and UV curable inks common to wide format digital printing systems.

The grey permanent adhesive offers excellent opacity and exceptional repositionable qualities.

AutoMARK™ Concept 230 Premium is specifically engineered for use in most vehicle wrap and decal applications.

The 90# air-egress liner allows for good lay-flat and air-free application.

To be used with Concept 231 Automark Premium 2.4 mil Calendered clear gloss vinyl over-laminating film.



Surface characteristics include:

- Corrugations
- Rivets
- Flat Slight to Moderate Curves

- Vans
- Trucks
- Sedans of all Sizes
- Fleet
- Recreation Vehicles

SPECIAL PACKAGE OFFER

1 roll of #230 white AutoMark 54"x150 ft. and
1 roll of #231 clear UV Wrap laminate 54"x150ft.
for a package price of **999.00**



Up to 7 years outdoor durability
Air-Free application
Excellent opacity and conformability
Excellent print quality with solvent, eco-solvent, and UV printers
(UV inkjet ink should be used on flat surfaces only)

Graphic Commerce Ltd. Mississauga, On phone (905)624-3124 toll free 1-800-543-2796

Concept[®]

APPLICATION CHART

CONCEPT SERIES	General Signage, Displays, P.O.P.	Vehicle Wraps	Fleet & Vehicle Graphics	Clear (Transparent)	Low Surface Energy	Translucent	Semi-Rigids	Transit (Outdoor Advertising Media)	Windows (Removable "R" - Permanent "P")	Walls (Smooth Dry Wall-Removable)	Walls (Moderately Textured Surfaces)	Floors (Tile & smooth sealed cement)	Carpet (Short loop commercial)	Outdoor	Indoor
201	●													●	●
201HTAP	●			●										●	●
201OAP	●													●	●
201OAPAE	●													●	●
202	●							● R						●	●
203	●													●	●
203OAP	●													●	●
203OAPAE	●													●	●
204	●							● R						●	●
205	●		●											●	●
206	●		●					● R						●	●
207	●		●					● R						●	●
208	●							● R						●	●
209	●						●							●	●
210	●									●				●	●
212	●										●			●	●
214	●											●		●	●
216	●													●	●
219	●		●			●		● R						●	●
220	●					●								●	●
221	●					●		● R						●	●
222	●					●								●	●
223	●					●		● R						●	●
224					●			● P						●	●
225					●			● R						●	●
226	●					●			●					●	●
228					●		●	● R						●	●
229	●					●			●					●	●
230	●	●	●											●	●
232	●	●	●					● R						●	●
234	●								●					●	●
235	●			●										●	●
246	●		●											●	●
247	●		●											●	●
250	●								●					●	●
252	●								●					●	●
255	●		●					● R						●	●
270	●							● R						●	●
275	●			●			●							●	●
285				●						●				●	●
780	●	●	●											●	●
781	●	●	●											●	●
782	●	●	●											●	●
790AE								● P						●	●

Graphic Commerce Ltd. 1675 Sismet Road -Units 4&5 - Mississauga, On L4W 2K8

phone (905)624-3124 toll free 1-800-543-2796

email - info@graphiccommerce.com

Note- All of the following products are available by phone or email only. Shopping Cart not in effect for these items.



Pressure Sensitive Vinyl Decal Sheet & Roll Stock

Printability: Note- These vinyl sheets and rolls are printable with screen printing vinyl inks or UV cured screen printing inks.



90lb. layflat liner



MATTE

MATTE

Decal Stock		Sheets			Adhesive - Description	
MATTE VINYL - 3.4 mil		SHEETS 27" X 38"				
DESCRIPTION	ADHESIVE	PRICE PER SHEET				
		1-99	100	250		
MATTE WHITE VINYL - PERM. ADHESIVE Non Top Coated - VFW-NTC-AP/90#		3.75	3.15	2.80	Permanent	
MATTE WHITE VINYL - REMOV. ADHESIVE Non Top Coated - VFW-NTC-AR/90#		3.75	3.15	2.80	Removable	
MATTE WHITE VINYL - LOW TACK REMOV. Non Top Coated - VFW-NTC-ARLT/90#		4.55	3.95	3.65	Low Tack	
MATTE WHITE VINYL- BLOCKOUT PERM. ADHES. Non Top Coated - VFW-NTC-OAP/90#.		5.30	4.60	4.15	Blockout	
MATTE WHITE VINYL HIGH TACK PERM.ADHES. Non Top Coated - VFW-NTC-HTAP/90		5.10	4.20	3.95	Hi-Tack	
MATTE CLEAR VINYL - PERM. ADHESIVE Non Top Coated - VFMC-NTC-AP/90		4.85	4.10	3.90	Clear Vinyl	

GLOSS

GLOSS VINYL - 3.4 mil		SHEETS 27" X 38"				
DESCRIPTION	ADHESIVE	PRICE PER SHEET				
		1-99	100	250		
GLOSS WHITE VINYL - PERM. ADHESIVE Non Top Coated - VFGW-NTC-AP/90		4.70	3.95	3.75	Gloss Perm.	
GLOSS WHITE VINYL - LOW TACK REMOV. Non Top Coated -VFGW-NTC-ARLT/90 GLOSS		4.70	3.95	3.75	Gloss Remov.	
CLEAR VINYL - PERM. ADHESIVE Non Top Coated - VFC-NTC-AP/90		4.70	3.95	3.75	Clear Perm.	
GLOSS CLEAR VINYL - LOW TACK REMOV. Non Top Coated - VFC-NTC-ARLT/90		4.85	3.75	3.30	Gloss Low Tack	

MATTE

VALUE VINYL - 3.2 mil		SHEETS 27" X 38"				
DESCRIPTION -All the same features as the 3.4mil matte above but with a price reduction for 3.2mil		PRICE PER SHEET			Economy Vinyl	
		1-99	100	250		
MATTE WHITE VINYL - PERM. ADHESIVE Non Top Coated - VFWM-NTC-AP/90#		3.10	2.60	2.30	White Perm.	
MATTE WHITE VINYL- LOW TACK REMOV. Non Top Coated - VFWM-NTC-ARLT/90#		3.35	2.80	2.60	White Low Tack	

STATIC

STATIC VINYL General Formulations 7 mil Static Cling Vinyl						
Gloss Clear or Gloss White sheets have a 10 pt printable lay-flat release liner. Rolls have a 90# lay flat release liner. G/F Static Vinyls are UV and Solvent Ink Jet printable. Also screen printable with GP series. Not recommended for lettering or screening with enamels. Test prior to using.	SHEETS 27" X 38" -10 pt. Liner			ROLL 54"x75 ft. - 90# liner		Static Cling White & Clear
	PRICE PER SHEET clear or white			PRICE PER ROLL		
	1-149	150	300	clear	white	
	4.25	3.45	3.15	206.00	212.00	

Note- All of the following products are available by phone or email only. Shopping Cart not in effect for these items.



PRESSURE SENSITIVE POLYESTER (MYLAR)

Sheet size 20" x 27" - Rolls 27" x 50 yards

TOP COATED - PERMANENT ADHESIVE - 90# STAY FLAT LINER

General FORMULATIONS	SHEETS (20" x 27") (Price per sheet)				ROLLS - 27" X 50 Yards Price per roll		CUT PIECES per yard price	
	1-99	100	250	500	(1)	(4)	27" width	
CLEAR POLYESTER CODE NO.							1 to 9 yds.	10 to 49 yds.
2 mil. CLEAR C2-STC-AP/90	2.50	2.30	2.10	2.00	204.10	185.75	4.95 yd.	4.65 yd.
SILVER (CHROME) POLYESTER								
2 mil. BRIGHT SILVER S2-STC-AP/90	3.10	2.80	3.00	2.40	254.90	222.50	6.50 yd.	5.70 yd.
2 mil. MATTE SILVER MS2-TC-AP/90	4.90	4.65	4.50	4.10	373.70	356.40	8.85 yd.	7.90 yd.
GOLD POLYESTER								
2 mil. BRIGHT GOLD G2-STC-AP/90	6.05	5.60	5.40	5.10	442.80	415.80	10.60 yd.	9.30 yd.
WHITE POLYESTER								
2 mil. WHITE POLYESTER W2-STC-AP/90	4.10	3.75	3.55	3.25	309.60	604.80	7.55yd.	6.80 yd.
BRUSHED POLYESTER								
2 mil. BRUSHED SILVER - BS2-STC-AP/90	4.45	4.20	4.10	3.65	368.30	336.80	8.85 yd.	7.70yd.
2 mil. BRUSHED GOLD - BG2-STC-AP/90	6.50	6.10	5.95	5.50	462.25	442.80	10.80 yd.	9.55 yd.

SOLID ALUMINUM FOIL

Price per Sheet - 13.75 per sheet

Inquire for quantity prices

2 mil gloss silver hard foil - sheet size 20" x 27" Top Coated - Permanent Adhesive 90 lb. Sta Flat Liner.

TAMPER PROOF MYLAR

Discontinued

1.5 mil Bright Silver Polyester Will destruct in a void pattern Top Coated - Permanent Adhesive



CLEAR CALENDERED OVERLAMINATE

This 3 mil calendered overlaminate film has been specifically developed for digital printing. Coated with a solvent based permanent pressure sensitive adhesive, it is particularly suitable for indoor, outdoor signs, exhibition displays, window graphics, POP displays, steel rule and thermal diecut. The moisture stable liner also provides excellent lay-flat qualities.

Available in clear gloss and matte clear and lustre clear. Up to 5 yr. outdoor durability under normal exposure conditions.

Prices per yd.

3 mil Matte/Lustre/Gloss - up to 5 yr. exterior	24"	30"	36"	48"	54"	60"	
50 Yards	3.25	4.10	5.20	6.65	7.40	8.20	
25 to 49 Yards	4.05	5.10	6.45	8.25	9.15	10.15	
10 to 24 Yards	5.20	6.45	8.20	10.45	11.60	12.90	

Specify Matte or Lustre or Gloss for your order



CLEAR POLYESTER OVERLAMINATES

Prices per yd.

1 mil CLEAR Polyester Overlaminate (Matte) Indoor			54"	60"	
50 Yards			6.40	7.45	
25 to 49 Yards			8.30	8.95	
10 to 24 Yards			11.10	10.80	
2 mil CLEAR Polyester Overlaminate (Glossy) Indoor			54"	60"	
50 Yards			7.05	7.65	
25 to 49 Yards			7.60	8.20	
10 to 24 Yards			9.10	10.10	

KPMF Metallic Wrap Cast Vinyl with Air Release Liner



KPMF WRAPS & LAMINATES!

KPMF Wraps & Special Effect Laminates - manufactured from
Graphic Commerce Ltd.



KPMF Premium Car Wrapping Films are a range of dual cast PVC films, specifically developed for vehicle wrapping. These films are formulated using the latest advances in chemical and pigment technology to offer exceptional dimensional stability and long term durability. They range in thickness, from 3.3mil to 4.3mil, depending on the colour. These films are also removable, using heat and/or chemicals, up to 3 years after installation from a range of substrates. These films have a life expectancy of 7 to 10 years in vertical applications. *Color Card Available on request*

[application guide](#)

[product data sheet](#)



K75402 - Gloss Atlantic Pearl



K75403 - Gloss Vengeance Red



K75405 - Gloss Indulgent Blue



K75406 - Gloss Momentum Pink



K75407 - Gloss Envious Green



K75409 - Gloss Solar Flash



K75440 - Gloss Magnetic Black



K75441 - Gloss Excelsior Blue

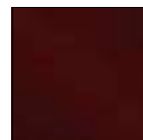

K75447 - Gloss Midnight Crimson Bloom

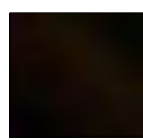

K75448 - Gloss Phantom Black Metallic

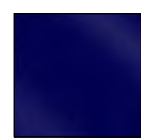

K75452 - Gloss Opulent Indigo



K75468 - Gloss Imperial Orchid

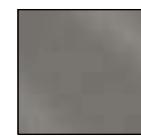

K75501 - Matte Iced Silver Titanium



K75502 - Matte Iced Orange Titanium



K75505 - Matte Iced Blue Titanium



K75506 - Matte Iced Red Titanium

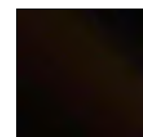

K75528 - Matte Phantom Black



K75534 - Matte Iced Yellow Titanium



K75538 - Matte Sonic Yellow Pearl



K75539 - Matte Siberian Pearl



K75540 - Matte Crystalline White



K75542 - Matte Viper Green



K75543 - Matte Java Brown



K75544 - Matte Trenton Blue



K75545 - Matte Russet Red



K75549 - Matte Anodized Bronze



K75551 - Matte Magnetic Black

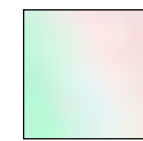

K75552 - Matte Aurora Pearl



K75554 - Matte Autumn Fire



K75560 - Matte Platinum Dark Sage



K75568 - Matte Iced Amethyst Titanium

Frozen Vehicle Wrapping Films

Matte Black in the shade - these frozen films sparkle and shine in vibrant colour when exposed to bright lights or sunshine.



K75573 - Frozen Ruby



K75575 - Frozen Mystic Pink



K75577 - Frozen Emerald



K75578 - Frozen Sapphire

Absolute Matte Wrapping Films

Developed for vehicles that have EXTREME matte finishes



K75801 - Absolute Matte Mythos Red



K75802 - Absolute Matte Quantum Blue



K75803 - Absolute Matte Royal Amethyst

Prices - all items are 60" wide	1-4 yards	5-11 yards	12-24 yards	25 yards
	60.90 yd.	54.60 yd.	46.70 yd.	42.00 yd.

Wrap vinyl & Laminates



Opaque Vehicle Wrapping Films

Airelease Liner - Up to 10 year durability

VWS IV (Vinyl Wrapping System) is a range of premium quality cast PVC films specifically developed for vehicle wrapping. These premium cast products are formulated using the latest advances in chemical and pigment technology to offer exceptional dimensional stability and long term durability. The combination of soft cast vinyl formulation and specific adhesive design offers excellent conformability into recesses, and adhesion which allows the film to be removed using heat and/or chemicals up to a period of three years from a range of substrates (subject to exceptions covered in the warranty).



K75411 - Gloss Chalk White



K75415 - Gloss Ominous Grey



K75531 - Matte Stealth Tundra

Prices	60" Wide
1 to 4 yds.	56.70 yd.
5 to 11 yds.	50.65 yd.
12 to 24 yds.	43.00 yd.
25 yds.	38.85 yd.

[application guide](#)

Starlight & Pearlescent Vehicle Wrapping Films

KPMF Starlight & Pearlescent Wrapping Films are a range of dual cast PVC films, specifically developed for vehicle wrapping. These films are formulated using the latest advances in chemical and pigment technology to offer exceptional dimensional stability and long term durability. They range in thickness, from 3.3mil to 4.3mil, depending on the colour. These films are also removable, using heat and/or chemicals, up to 3 years after installation from a range of substrates. These films have a life expectancy of up to 7 years in vertical applications.

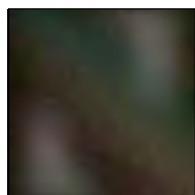

K75470 - Gloss Morpheus Black
(Rainbow Starlight Effect)



K75479 - Gloss Copper/Black Starlight

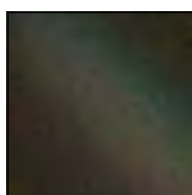

K75571 - Matte Morpheus Black
(Rainbow Starlight Effect)

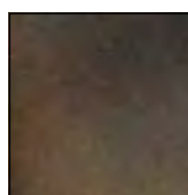

K75579 - Matte Burnished Bronze



K75584 - Matte White/Blue Pearlescent

Prices	60" Wide
1 to 4 yds.	67.70 yd.
5 to 11 yds.	60.90 yd.
12 to 24 yds.	54.60 yd.
25 yds.	49.85 yd.

[Application Guide](#)

Iridescent Vehicle Wrapping Films

KPMF Iridescent Vehicle Wrapping Films are a range of dual cast PVC films, specifically developed for vehicle wrapping. These films are formulated using the latest advances in chemical and pigment technology to offer exceptional dimensional stability and long term durability. They range in thickness, from 3.3mil to 4.3mil, depending on the colour. These films are also removable, using heat and/or chemicals, up to 3 years after installation from a range of substrates. These films have a life expectancy of up to 7 years in vertical applications.



K75408 - Gloss Iridescent Red/Black



K75460 - Gloss Iridescent Green/Black



K75464 - Gloss Iridescent Purple/Green

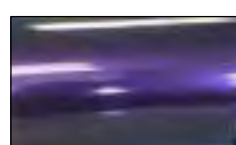

K75465 - Gloss Iridescent Purple/Black

Prices	60" Wide
1 to 4 yds.	67.70 yd.
5 to 11 yds.	60.90 yd.
12 to 24 yds.	54.60 yd.
25 yds.	49.85 yd.



K75466 - Gloss Iridescent Purple/Blue



K75469 - Gloss Iridescent Blue/Black



K75565 - Matte Iridescent Purple/Black



K75566 - Matte Iridescent Purple/Blue

[Application Guide](#)

Wrap vinyl & Laminates

KPMF WRAPS & LAMINATES!

KPMF Wraps & Special Effect Laminates, now available from Graphic Commerce Ltd.



K80000 Hybrid Car Wrapping

[application guide](#)

KPMF Hybrid Wraps are superior quality soft Polymeric PVC films formulated by using the latest advances in PVC and pigment technology to offer exceptional dimensional stability and excellent long-term durability. They are suitable for long term applications in outdoor and indoor environments, offering excellent cutting and weeding properties. The combination of soft vinyl formulation and specific Airelease adhesive design offers excellent conformability and adhesion which allows the film to be removed without leaving adhesive transfer. Typical applications include total vehicle cover, vehicle graphics, signs and decal applications which require exterior exposure of 5 to 7 years. The material is designed to be removable, under controlled conditions, up to a period of three years.



K88021 - Gloss Black - 60" wide



K88011 - Gloss White - 60 wide.



K89021 - Matte Black - 60"wide

Hybrid Pricing 60" wide material

Product No.	1-9 yds.	10-26 yds.	27 yds.
K88021 Gloss Black	30.95yd	25.00yd	22.00yd
K88011 Gloss White	29.75yd	24.50yd	21.00yd
K89021 Matte Black	32.25yd	26.50yd	23.00yd

K87021 CARBON FIBRE BLACK



60" wide sold

by the foot

1 to 9 ft. - 25.85 foot
10 to 49 ft. - 18.80 foot.
50 ft. - 14.45 foot.

[Click here for photo examples product data,](#)

K88025 Ultimate Hi Gloss Black Roof Wrap 60" width

[click for photos, specs, data,applic.](#)

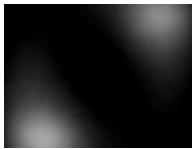

Ultimate Black is a high gloss self-healing black vinyl which is ideal for accents during wrapping. It installs like a PPF product using a wet application method because there is no air egress liner. The material can stretch slightly, but is not designed to wrap an entire vehicle. It is perfect for roofs, small accents and especially chrome deletes. The special coating allows it to have an unrivalled high gloss finish that will self heal from small scratches and maintain it's true black look for years.

PRICES - 60" Width - 1 to 4 yds.-68.00 yd. 5 to 9 yds.- 59.85 yd. 10 yd. Roll-56.70 yd.

K71000 Special Effect Laminates - 60" Width

[spec. sheet](#)

These films represent a luxury and innovative over-laminate that transform any application with the creation of a sparkling starlight or pearlescent appearance. These high quality 2 mil cast over-laminating films have been specially developed for use in the vehicle wrap and digital imaging industry to permanently enhance and protect wrap & print media. They offer a premium solution to over-laminating applications by using a solvent-base acrylic adhesive system.

Color Card Available on request



K71301 - Gloss Pink Starlight Laminate

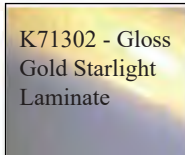

K71302 - Gloss Gold Starlight Laminate



K71303 - Gloss Pacific Blue Starlight Laminate



K71304 - Gloss Rainbow Starlight Laminate

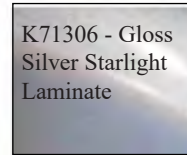

K71306 - Gloss Silver Starlight Laminate

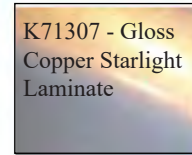

K71307 - Gloss Copper Starlight Laminate

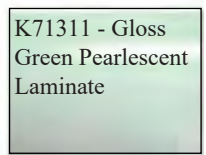

K71311 - Gloss Green Pearlescent Laminate

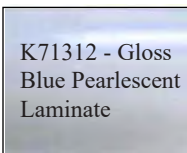

K71312 - Gloss Blue Pearlescent Laminate

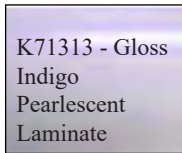

K71313 - Gloss Indigo Pearlescent Laminate

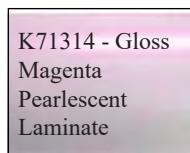

K71314 - Gloss Magenta Pearlescent Laminate



K71401 - Matte Pink Starlight Laminate



K71402 - Matte Gold Starlight Laminate



K71403 - Matte Pacific Blue Starlight Laminate

Prices	60" Wide
1 to 4 yds.	56.70 yd.
5 to 11 yds.	50.60 yd.
12 to 24 yds.	43.00yd.
25 yds.	38.85 yd.

Magnets for Vehicle Wraps Extra Strong



9.00 each



Knifless Tapes

[Click here for prices, Video, and Descriptions](#)

TAPES

FOAM TAPE - rolls: 33 metres/36 yds.



A 1/16" cross-linked polyethylene foam tape, double coated with a solvent-based acrylic pressure sensitive adhesive. Can be applied to any clean smooth surface. Capable of holding great weights. Used for mounting, cushioning, and vibration-damping.

HOT PRICE
LOW PRICE

1/2"	(12mm)	9.85
3/4"	(18mm)	11.95
1"	(24mm)	15.95

DOUBLE SIDED TAPE



Adhesive on both sides of tape. Excellent for mounting. Easy to use. Holds very tightly.

WIDTH	CASE	BROKEN CASE	FULL CASE
1/2" x 36 yd.	48	9.50	8.50ea.
3/4" x 36 yd.	36	12.60	11.25
1" x 36 yd.	24	17.25	15.50



203 Masking Tape

3M™ General Purpose
The Standard of the Industry

It sticks to many surfaces and removes cleanly with no residue.



60 yd rolls

WIDTH	PRICE	CASE	PRICE
	Part Case		Full Case
3/4"	3.00	48	2.65ea.
1"	3.95	36	3.50ea.
2"	7.45	24	6.55ea.

SIGNWRITERS TAPE - 3/8" Green x 72 vd. - rolls- 2.85 per roll



PIN STRIPING



2 mil cast high performance vinyl. 8 year exterior durability. Available in over 50 colours. See KPMF - STANDARD & METALLIC colour range on page 2 of this catalogue or refer to our SMF colour card. Priced by the 55 yard roll.

SIZE	PRICE	SIZE	PRICE	SIZE	PRICE
1/4"	27.70	1"	64.60	4"	189.20
1/2"	41.25	2"	99.00	5"	235.40
3/4"	59.15	3"	126.90	6"	272.80

The above is Clear Premasked The above is Clear Premasked The above is Paper Premasked

REFLECTIVE STRIPING

KIWA Premium fleetgrade reflective vinyl. 7 year exterior durability. Conforms to flat, irregular, and corrugated surfaces.

Available in 10 colours. - Sold in 50 yard rolls.

See colour range for KIWA reflective on our SMF colour card.



SIZE	PRICE	SIZE	PRICE	SIZE	PRICE
1/4"	33.65	1"	115.50	4"	440.00
1/2"	64.85	2"	226.60	5"	521.40
3/4"	96.70	3"	324.50	6"	633.60

SOLVENT RESISTANT TAPE

Durable, white polyethylene reinforced cloth tape is pressure sensitive. Has tremendous tack. Perfect for sealing off inside of frames, protecting edges and guides, etc. Molds into all crevices and corners. Simply removed.

2"x60yd.roll-41.95



BANNER TAPE

1" x 60 yds - Double Coated

Has a very aggressive acrylic adhesive.

Used in hemming

& bonding vinyl materials

Roll- 29.95



[click here for video](#)

PACKAGING TAPE- Clear 3" core

2" x 100 metres - "Shurtape" Brand 2.95 roll
3" x 100 metres "Shurtape" Brand 4.95 roll
less 10% on cases - (2" -36rolls case - 3"-24 rolls case)



watch demo videos

Knifeless Tape

Knifeless tape is a tape that can be used to cut graphic film without a knife see specs



esign Line Tape
1/8" x 164 ft. 58.95



Knifeless Perf Line
1/4" x 164 ft. 58.95



Knifeless Finish Line
1/8" x 164 ft. 58.95



Knifeless Tri-line
6mm x 164 ft. 71.45
9mm x 164 ft. 71.45



Knifeless Bridge Line
1/2" x 164 ft. 71.45

TRANSPARENCY MOUNTING FILM

CRYSTAL CLEAR - # 106-54 Double Coated Adhesive Film

Ideal for adhering name plates, plastic to plastic, posters to smooth surfaces, transparencies to plexiglass in light boxes, etc.

ROLLS	CUT PIECES
969.00	22.15 yd.

54" X 50 YARDS



"LEAD FREE"

[see color card here](#)

Lettering Enamels

"ONE SHOT" LETTERING ENAMELS are oil based lead free superior quality high gloss enamels for interior or exterior use on metal, glass (not for use on windshields), wood, masonite, MDO and enamel receptive banner and vinyl materials. Intended for sign writing on store fronts, vehicles and wherever fine lettering work is desired. They have outstanding hiding, durability and excellent resistance to sagging. Superior flow characteristics assure the virtual absence of brush marks and provide a clean, sharp edge.

[click here for SDS sheets \(formerly MSDS\)](#)



[click here for PANTONE Conversion Formula for 1 Shot](#)

CASES - less 10% -1/2 pints (12 per case), pints (12 per case), quarts (6 per case), gallons (2 per case)

CODE	COLOR	1/2 PT.	QTS.	GALLON	CODE	COLOR	1.2 PT.	QTS.	GALLON
100L	Vermillion	36.90	96.15		144L	Medium Green	28.40	71.85	
101L	Lettering White	26.30	66.00	211.90	148L	Dark Green	28.40	71.85	
102L	Fire Red	37.85	99.90	321.30	149L	Aqua	26.30	66.10	
103L	Polar White	26.30	66.00	211.90	150L	Blue Green	26.30	66.10	
104L	Bright Red 106L	36.90	96.15	309.65	151L	Robin Egg Blue	29.10	73.90	
106L	Kool Crimson	35.95	93.95		152L	Light Blue	26.30	66.10	
108L	Maroon	35.95	93.95		153L	Process Blue	35.95	93.90	
109L	Metallic Gold	49.00	164.10		154L	Peacock Blue	29.10	73.90	
110L	Metallic Copper	49.00	164.10		155L	Reflex Blue	35.95	93.95	302.25
111L	Metallic Brass	49.00	164.10		156L	Brilliant Blue	29.10	73.90	
114L	Medium Brown	26.30	66.10		157L	Kansas City Teal	26.30	66.10	
115L	Dark Brown	26.30	66.10		158L	Dark Blue	26.30	66.10	211.90
116L	Ivory	26.30	66.10		160L	Violet	26.30	66.10	
117L	Tan	26.30	66.10		161L	Proper Purple	43.15	114.15	
118L	Chamois	26.30	66.10		162L	Purple	43.15	114.15	
120L	Coral	32.60	82.65		163L	Magenta	43.15	114.15	
124L	Orange	33.35	85.75		164L	Dark Magenta	43.15	114.15	
130L	Primrose Yellow	32.60	82.65		165L	Rubine Red	43.15	114.15	
132L	Lemon Yellow	32.60	82.65		168L	Salmon Pink	36.90	96.15	
134L	Chrome Yellow	32.60	82.65		191L	Imitation Gold	28.40	71.85	
141L	Sublime Green	32.60	82.65		193L	Metallic Silver	29.10	73.90	236.30
142L	Emerald Green	28.40	71.85		195L	Medium Grey	26.30	66.10	
143L	Process Green	29.10	73.90		199L	Lettering Black	26.30	68.85	220.45

1 SHOT CLEAR COATINGS

CODE	DESCRIPTION	GAL	QTS.	AEROSOL
4003	SIGN RESTORING CLEAR GLOSS		37.50	-
4005	SPEED DRY U/V ACRYLIC CLEAR GLOSS	231.15	72.10	-
4005A	SPEED DRY U/V ACRYLIC CLEAR GLOSS AEROSOL			24.15
1 SHOT ANTI-GRAFFITI CLEARS				
4016	ANTI-GRAFFITI CLEAR GLOSS - PART A	246.00	80.25	click here for specs on anti-graffiti
4018	ANTI-GRAFFITI CLEAR MATTE- PART A	246.00	-	
4020	ANTI-GRAFFITI CLEAR - PART B	246.00	80.25	



PEARLESCENT COLOURS



Designed to be used wherever high quality lettering is required. This unique product allows sign artists to incorporate the special effect properties of Pearlescent pigments into their hand lettering work.

1/2 Pint 31.05

[click here for color chart](#)

900P	Vermillion	950P	Blue Green
904P	Bright Red	953P	Process Blue
930P	Primrose Yellow	955P	Reflex Blue
943P	Process Green	962P	Purple
948P	Dark Green	964P	Dark Magenta

GET 1 SHOT FORMULAS FOR PANTONES®

[click here for New Formula Tool](#)



[click here for MSDS sheets on 1 Shot.](#)

Thinners - Reducers - Additives - Solvents



6000 REGULAR REDUCER
6001 LOW TEMPERATURE REDUCER
6002 HIGH TEMPERATURE REDUCER

Formulated to improve flow at normal temperature conditions by reducing viscosity without significantly altering the quality of the coating being reduced. The Low Temp Reducer is formulated to improve flow and levelling at low temperatures by reducing the viscosity and accelerating the evaporation rate without significantly altering the quality of the coating being reduced. The High Temp Reducer is formulated to improve the flow and levelling at high temperatures by reducing the viscosity and slowing down the evaporation rate without significantly altering the quality of the coating being reduced. The reducers may be used with Lettering Enamels, Bulletin Colours, Art and Sign Poster Colours, Pearlescent Enamels or Fluorescent Colours.



#6000	Regular Reducer	47.70/qt.
#6001	Low Temperature Reducer	37.35/qt.
#6002	High Temperature Reducer	35.30/qt.



HARDENER (4007) is designed to accelerate drying time for Lettering Enamels, Bulletin Colours and Pearlescent Enamels. The Hardener will extend colour life, increase gloss, and improve adhesion to most substrates. Adding Hardener to the paint will aid in preventing "lifting" when overcoating with "UCO" Urethane Clear Overcoat, Speed Dry UV Acrylic Clear or an automotive "style" clearcoat. Add up to 10% in volume into 1Shot or Chromatic paint. Recommended shelf life is 14 days after tin is opened.



#4007	Hardener	78.20 1 pt.
-------	----------	-------------

TINTING



TINTING BLACK (4001L) AND WHITE (4002L) are tinting bases for use with Lettering Enamels and Bulletin Colours in achieving various shades without affecting the properties of the base coatings.



COLORS	1/2 pt.
4001 Tinting Black	37.35
4002 Tinting White	35.30

THINNER

EDGE "THE SIGN PAINTER'S THINNER"
(4311001)

Is a pre-mixed combination of flow enhancer and reducer for larger scale painting and lettering. This single component reducer/flow enhancer makes it easy to keep the paint flow up, especially when hand lettering larger scale copy and graphics as well as panels and backgrounds.

4311001	Thinner Quart	18.50
4311001	Thinner Gallon	42.50

REDUCERS, ADDITIVES, SOLVENTS

Replacement Ink Jet Cartridges

for "Roland" Eco and "Mimaki" Eco and "Mimaki" SS21 Solvent Ink jet Printers

Price: - 115.00 ea.

440 ml. cartridge size:

Available in:
Black
Cyan
Magenta
Yellow

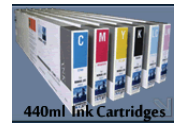

Ink-mate compatible cartridges by "Alphachem" one of the world's leaders in reliable ink-jet technology. Satisfaction assured. 440 ml. cartridge size

Cleaning Fluid Cartridge for above - 90.00 ea.

CARTRIDGES

SANDBLAST

SANDBLAST Stencil

Hartco All Purpose Application

SANDBLAST STENCIL

Sandblast Stencil 400 series - 25 mil

A sandblast resistant material used for sandblasting wood (raw or painted), glass, polyurethane foam, fiberglass, and other similar substrates.

Air pressure limits - up to 90psi (80 psi on large grits)





width	per yard	10 yd. roll	width	per yard	10 yd. roll
15"	28.80	185.20	30"	57.60	370.60
20"	38.50	247.05	48"	92.15	592.20
24"	46.10	296.10	60"	115.15	740.30

IMAGE EDGE

Image Edge™ Trim An enhancing and protective cap for mounted graphics.

Range of glossy and metallic finishes. Permanently bonds to rigid substrates

Edges are mitered and glued to back of mounting. Image Edge Trim Machine available on request.

Image Edge Lineals			Sold in lengths of 8 ft. each	
PROFILES	PART# / COLOR	Price per 8 ft. length		
 3/16" (5mm)	041014 Chrome	5.80 ea.	 1/2" (12mm)	011014 Chrome
	041100 Gold			011100 Gold
	041013 Black			011013 Black
	041023 White			011023 White
	041018 Red			011018 Red
	041027 Blue			011027 Blue
041020 Matte Black	011020 Matte Black			
 13/16" (22mm)	036014 Chrome	11.95 ea.	 13/16" (22mm)	036014 Chrome
	036100 Gold			036100 Gold
	036013 Black			036013 Black
	036023 White			036023 White
036020 Matte Black	036020 Matte Black			

Also available in 1/8", 5/32", 1/4", and 3/8" in gloss black, gloss white, chrome & gold.

Prices

1/8" - 4.00 ea.
5/32" - 4.95 ea.
1/4" - 5.95 ea.
3/8" - 8.50 ea.

CORNER ROUNDER

LASSCO Cornerrounders®

Standard Cutting Unit Diagram

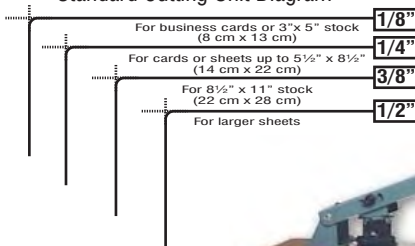

Desktop Cornerrounders®

Model 20 \$439.00

The Model 20 Desk Top Cornerrounder® handles up to 1/2" (13mm) of stock per cut. Equipped with your choice of one cutting unit: 1/8", 1/4", 3/8" or 1/2". The table leaf extends to accommodate 8-1/2" x 11" or larger sheets.

* Capacity of cutting unit is dependent on material being cut and radius of being used.

Desktop Heavy Duty Cornerrounder® 757.00

CR-50B Heavy Duty Bench Model Cornerrounder® designed with smooth rigid cutting action for hard-to-do jobs. Accepts full range of interchangeable cutting units (1/16" to 1/2" radii) with a maximum cutting depth of 1/2". One standard cutting unit (1/8", 1/4", 3/8", or 1/2") included.

Cutting Units and Attachments

Standard sizes - 1/8", 1/4", 3/8" 1/2"	237.00
Special sizes - 1/16", 3/32", 3/16", 5/16"	307.00
Large radius - 3/4", 1", 1 1/2"	419.00

SIGN & DISPLAY SUPPLY CATALOGUE



Vinyls



“Coroplast”



Easels-self stick
single & double wing

INDEX	
<u>A-Frames</u>	<u>p.26-27</u>
<u>Art Supplies</u>	<u>p.30</u>
<u>Banner Material</u>	<u>p.24-25</u>
<u>Banner Stands</u>	<u>p.28-29</u>
<u>“Coroplast”</u>	<u>p.5</u>
<u>Cutting Tools</u>	<u>p.22-23</u>
<u>Digital Print media</u>	<u>p.31-41</u>
<u>Easels - Card</u>	<u>p.1</u>
<u>Foam Board</u>	<u>p.5-6</u>
<u>Grommets</u>	<u>p.4</u>
<u>Mats - Cutting</u>	<u>p.3</u>
<u>Premask Tape</u>	<u>p.18</u>
<u>“Rapid Tac”</u>	<u>p.19</u>
<u>Ruler-Safty</u>	<u>p.3</u>
<u>1 Shot</u>	<u>p.56-57</u>
<u>Squeegee Applicators</u>	<u>p.20-21</u>
<u>Tapes -</u>	<u>p.55</u>
<u>Vinyls - Films</u>	<u>p.7-17</u>
<u>Wrap Vinyl</u>	<u>p.52-54</u>



Foamboards



Cutting Mats



“A” Frames
Sign Stands

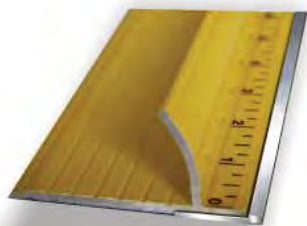

Safety Rulers



1 Shot Lettering Enamel



Grommets & Machines

Banner Stands



Vehicle Wrap

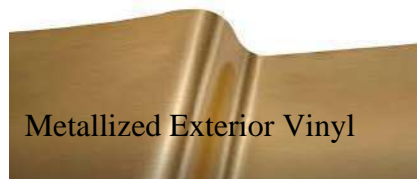

Metallized Exterior Vinyl



“Tufbak” Adhesive Stencil